

LOC		DIST		REVISIONS			
ES	00	P.	LTH	DESCRIPTION	DATE	DWN	APVD
		L9		REV PER ECR-12-010228	07JUN2012	AY	SZ
		M1		ADD 5-6450130-3	25JUL2012	OL	SZ

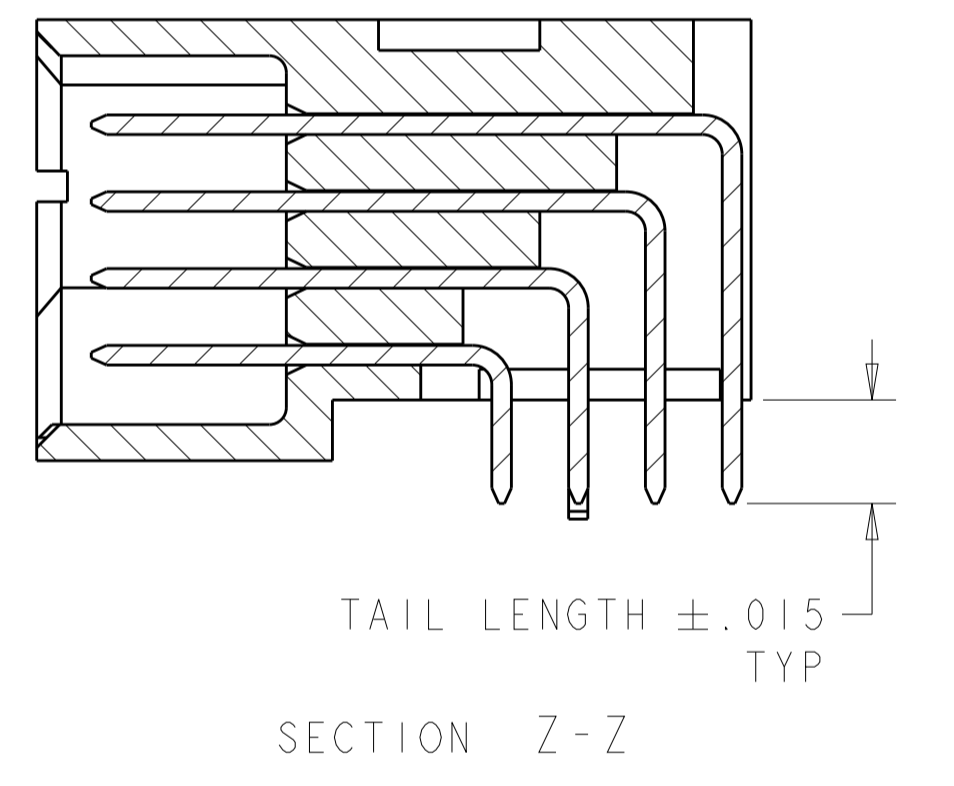
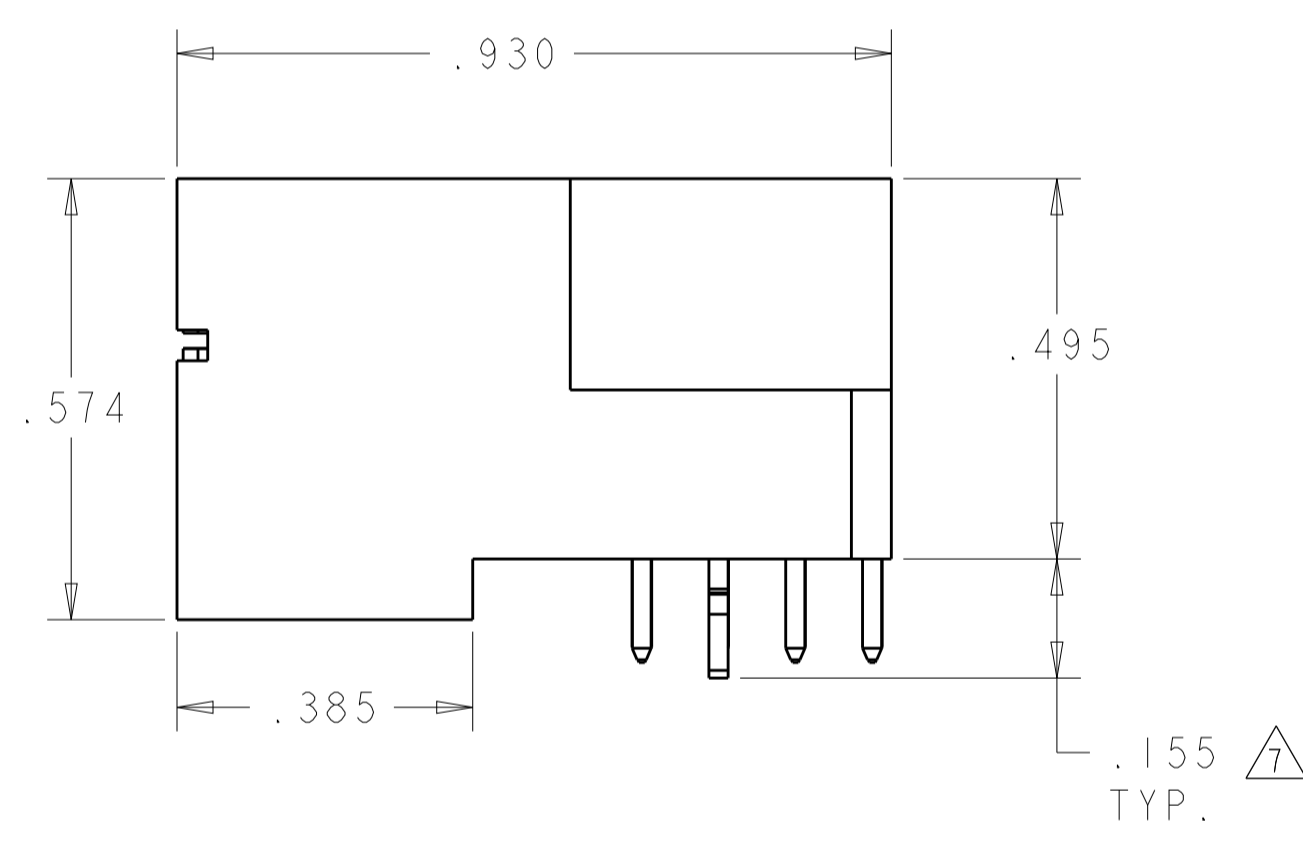
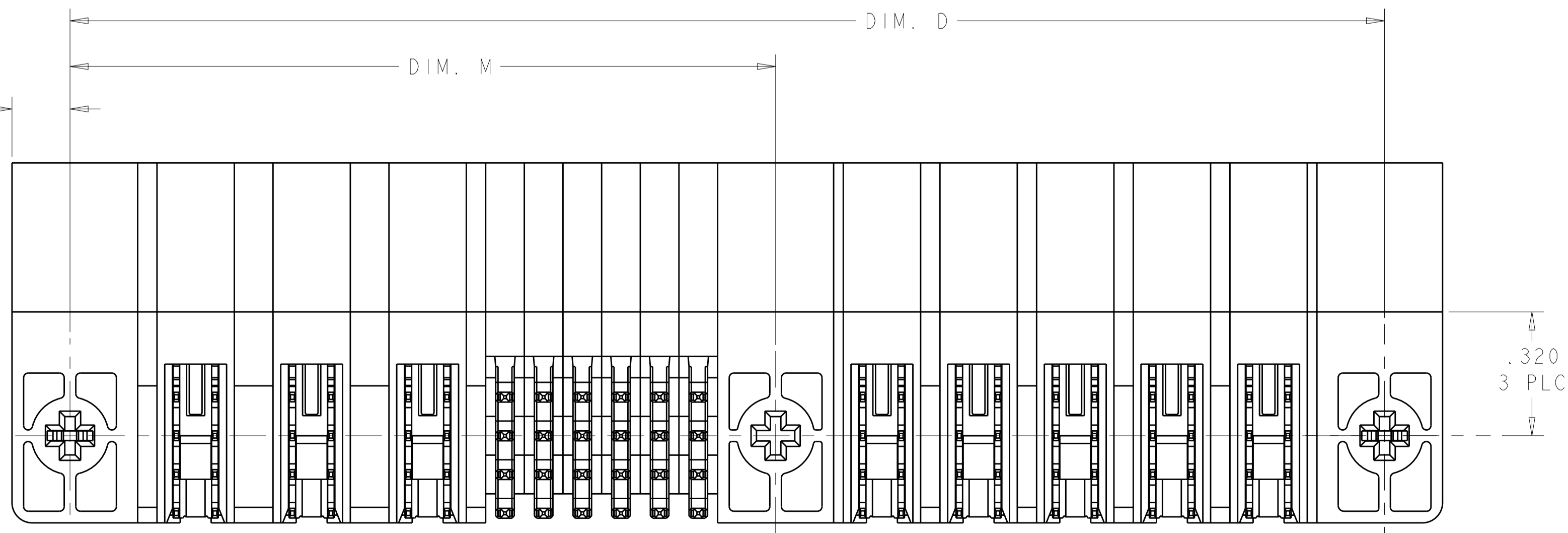
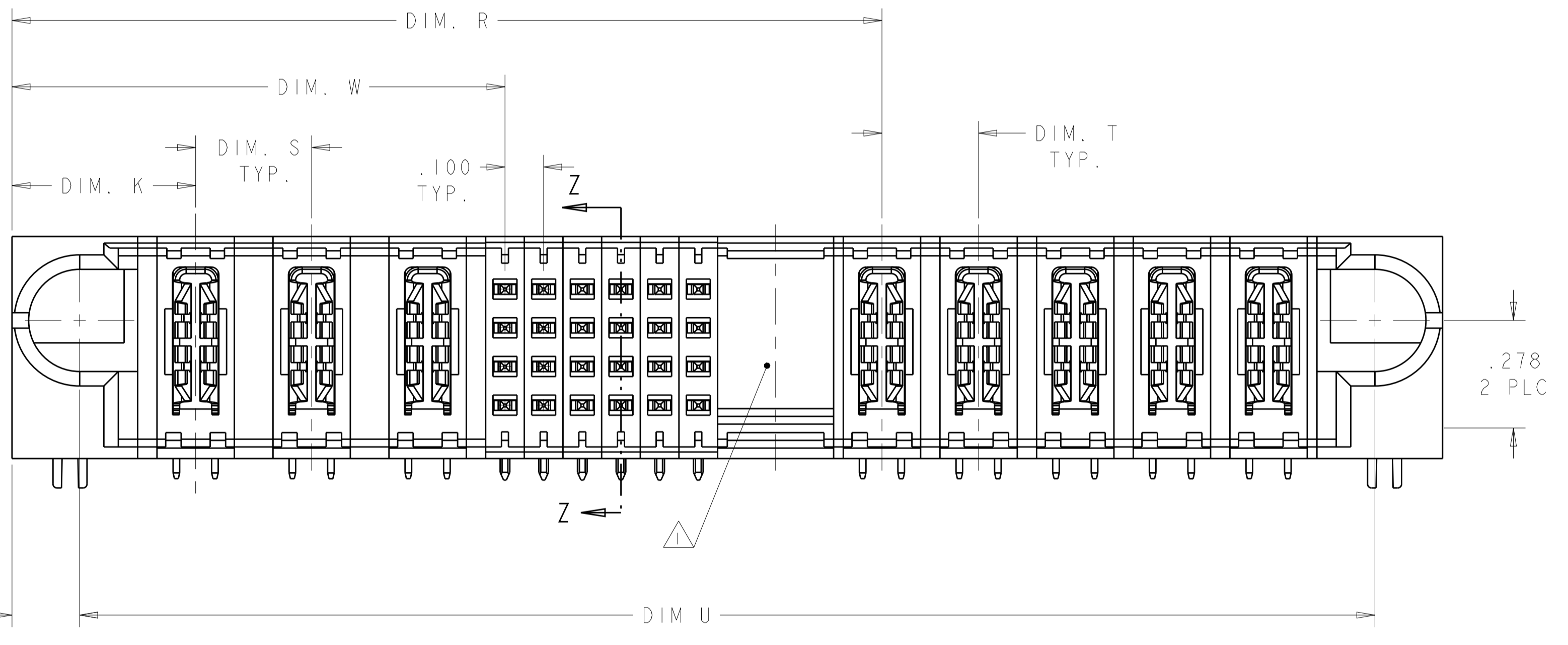
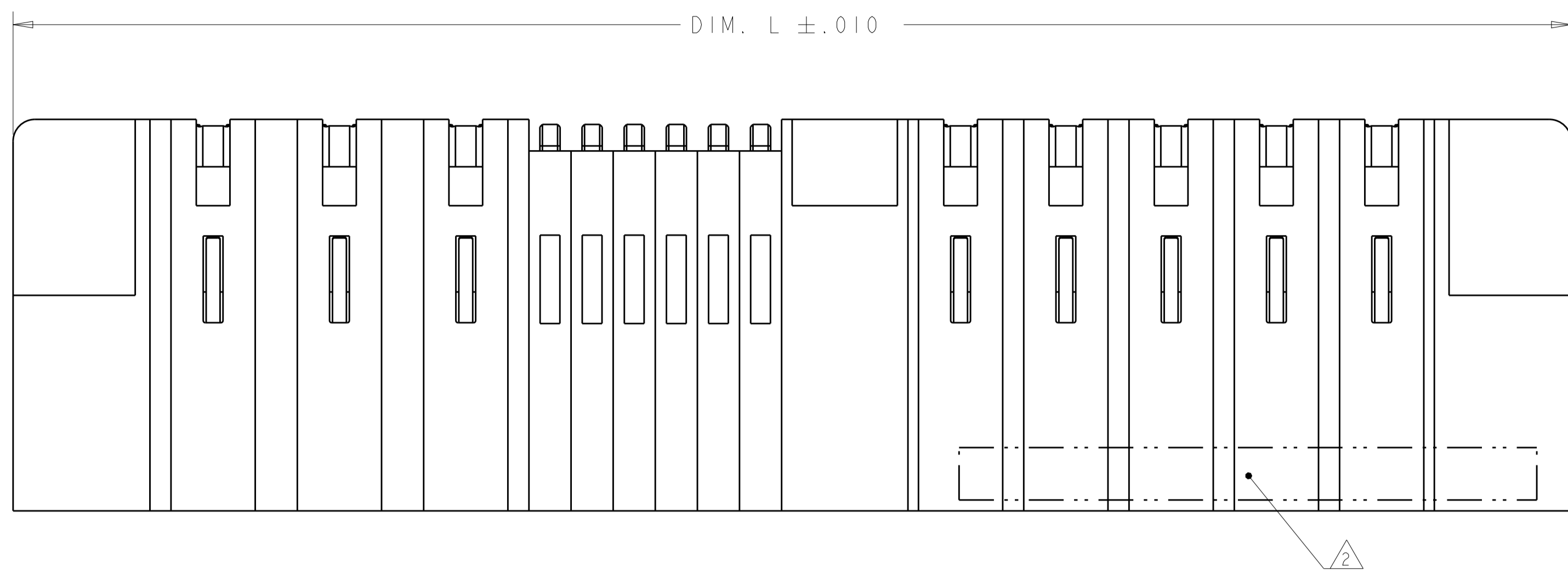

THIS DRAWING IS A CONTROLLED DOCUMENT.

DIMENSIONS: INCHES	TOLERANCES UNLESS OTHERWISE SPECIFIED: 0 PLC $\pm .01$ 1 PLC $\pm .01$ 2 PLC $\pm .01$ 3 PLC $\pm .005$ 4 PLC $\pm .0020$ ANGLES $\pm 30^\circ$	DWN: R.GRZYBOWSKI 4FEB2005 CHK: M.PERCHEK 14FEB2005 APVD: M.PERCHEK 14FEB2005	NAME: RIGHT ANGLE HEADER ASSEMBLY W/GUIDES MULTI-BEAM XL
MATERIAL: 3	FINISH: 4	PRODUCT SPEC: 108-1973 APPLICATION SPEC: 114-13038 WEIGHT: -	SIZE: A1 CAGE CODE: C=6450130 DRAWING NO: 100779
Customer Drawing		SCALE: 4:1	SHEET 1 OF 28 REV M2

STE TE Connectivity

LOC	DIST	REV	DATE	BY	APPV
ES	00				

- △ OPTIONAL CENTER MODULE WITH Ø.150 THRU HOLE OR HOLD DOWN FEATURE.
- △ "AMP", PART NUMBER, AND DATE CODE TO BE MARKED IN AREA SHOWN.
- △ MATERIAL: HOUSING - GLASS FILLED HIGH TEMP THERMO PLASTIC, UL94 V-0
 SIGNAL CONTACT - COPPER ALLOY
 POWER CONTACT - HIGH CONDUCTIVITY COPPER ALLOY
- △ CONTACT PLATING: NOBLE METAL PLATING ON CONTACT FUNCTIONAL AREA OF SIGNAL CONTACTS AND POWER CONTACTS.
- △ MECHANICAL CONNECTOR KEEP OUT ZONE.
- △ DATUM AND BASIC DIMENSIONS ESTABLISHED BY CUSTOMER.
- △ HOLD DOWN SEATING DEPTH DIMENSION FOR 6450130-4 IS .185 TYP
- △ PCB - ALL HOLE DIAMETERS ARE FINISHED HOLE SIZES.
- △ PCB - .0453 +/- .0010 DRILLED HOLES PLATES WITH .0003 MIN Sn OVER .001 TO .003 Cu PLATING TO ACHIEVE A .040±.003 DIA HOLE.
- △ VARIABLE DIMS. SHOWN ON VIEW

(L9) PART IS SHEET 27

DIM U	DIM S	DIM T	DIM R	DIM W	DIM D	DIM M	DIM L	DIM K	DESCRIPTION	PART NUMBER
2.350	.250	.250	1.250	.875	2.400	-	2.700	.450	2P + 12S + 5P	9-6450130-2
2.400	.250	.250	1.800	1.125	2.450	-	2.750	.450	3P + 24S + 3P	9-6450130-0
1.200	-	-	1.100	.625	1.250	-	1.550	.450	1P + 16S + 1P	8-6450130-9
1.900	.250	.250	1.550	.875	1.950	-	2.250	.450	2P + 24S + 2P	8-6450130-8
2.900	.250	.250	2.550	.875	2.950	-	3.250	.450	2P + 64S + 2P	8-6450130-7
2.400	.250	.250	1.800	1.125	2.450	-	2.750	.450	3P + 24S + 3P	8-6450130-6
1.300	-	-	1.200	.675	1.350	-	1.650	.450	1P + 16S + 1P	8-6450130-5
2.800	.250	.250	1.700	1.125	2.850	-	3.150	.450	3P + 20S + 5P	8-6450130-4
2.800	.250	.300	2.075	1.375	2.850	-	3.150	.450	4P + 24S + 3ACP	8-6450130-2
2.850	.250	.250	2.500	1.875	2.900	-	3.200	.450	6P + 20S + 2P	8-6450130-0
2.600	.250	.250	2.250	1.625	2.650	-	2.950	.450	5P + 20S + 2P	7-6450130-9
2.400	.250	.250	1.800	1.125	2.450	-	2.750	.450	3P + 24S + 3P	7-6450130-8
4.800	.250	.250	3.450	1.875	4.850	-	5.150	.450	6P + 60S + 6P	7-6450130-7
3.050	.300	.250	1.950	1.275	3.100	-	3.400	.475	3ACP + 24S + 5P	7-6450130-6
2.400	.250	.250	1.800	1.125	2.450	-	2.750	.450	3P + 24S + 3P	7-6450130-5
6.250	.250	△	5.050	4.375	6.300	-	6.600	.450	16P + 24S + 2P + 3ACP	7-6450130-4
2.000	.300	.250	1.650	1.325	2.050	-	2.350	.475	3ACP + 8S + 2P	7-6450130-1
2.500	.250	.250	2.150	.875	2.550	-	2.850	.450	2P + 48S + 2P	6-6450130-9
1.900	.250	.250	1.550	.875	1.950	-	2.250	.450	2P + 24S + 2P	6-6450130-7
2.500	.250	.250	2.150	1.425	2.550	-	2.850	.450	4P + 24S + 2P	5-6450130-8
6.300	△	△	3.925	3.275	6.350	-	6.650	.425	14P + 24S + 12P	5-6450130-6
3.100	.200	.200	2.225	1.375	3.150	-	3.450	.425	5P + 32S + 5P	5-6450130-5
2.400	.200	.200	1.900	1.225	2.450	-	2.750	.450	4HDP + 24S + 3HDP	5-6450130-3
2.300	.300	.250	1.950	1.275	2.350	-	2.650	.450	3ACP + 24S + 2P	5-6450130-1
4.000	.300	.300	2.675	1.925	4.050	-	4.350	.475	5ACP + 24S + 5ACP	5-6450130-0
3.000	.250	.250	2.150	1.425	3.050	-	3.350	.450	4P + 24S + 4P	4-6450130-9
3.300	.250	.250	2.450	1.375	3.350	-	3.650	.450	4P + 40S + 4P	4-6450130-8
3.100	.200	.200	2.225	1.375	3.150	-	3.450	.425	5P + 32S + 5P	4-6450130-5
2.100	.300	.250	1.750	1.275	2.150	-	2.450	.475	3ACP + 16S + 2P	4-6450130-3
1.900	.250	.250	1.550	.875	1.950	-	2.250	.450	2P + 24S + 2P	4-6450130-2
2.100	.200	.200	1.425	1.175	2.150	-	2.450	.425	4P + 8S + 4P	4-6450130-0
2.100	.300	.250	1.750	1.275	2.150	-	2.450	.475	3ACP + 16S + 2P	3-6450130-9
4.675	.250	.300	3.950	3.375	4.725	-	5.025	.450	12P + 20S + 3ACP	3-6450130-6
3.500	.250	.250	2.900	1.625	3.550	-	3.850	.450	5P + 48S + 3P	3-6450130-2
1.900	.250	.250	1.550	.875	1.950	-	2.250	.450	2P + 24S + 2P	2-6450130-9
3.250	.250	.250	2.900	1.125	3.300	-	3.600	.450	3P + 68S + 2P	2-6450130-8
2.300	.300	.250	1.950	1.275	2.350	-	2.650	.475	3ACP + 24S + 2P	2-6450130-6
2.600	.200	.200	1.925	1.175	2.650	-	2.950	.425	4HDP + 28S + 4HDP	2-6450130-4
3.200	.200	.200	2.125	1.575	3.250	-	3.550	.425	6P + 20S + 6P	2-6450130-3
2.800	.250	.300	2.075	1.375	2.850	-	3.150	.450	4P + 24S + 3ACP	2-6450130-2
3.500	.200	.200	2.225	1.775	3.550	-	3.850	.425	7P + 16S + 7P	2-6450130-1
5.450	△	△	3.075	2.425	5.500	-	5.800	.425	10P + 24S + 12P	2-6450130-0
4.400	.250	.250	4.050	.875	4.450	-	4.750	.450	2P + 124S + 2P	1-6450130-9
4.275	△	.250	3.175	2.500	4.325	-	4.625	.475	2ACP + 6P + 24S + 5P	1-6450130-8
1.900	.250	.250	1.550	.875	1.950	-	2.250	.450	2P + 24S + 2P	1-6450130-7
3.300	.300	.250	1.950	1.275	3.350	-	3.650	.475	3ACP + 24S + 6P	1-6450130-4
4.050	.250	-	3.950	.875	4.100	-	4.400	.450	2P + 120S + 1P	1-6450130-3
3.250	.250	-	3.150	.875	3.300	-	3.600	.450	2P + 88S + 1P	1-6450130-2
1.400	-	-	1.300	.625	1.450	-	1.750	.450	1P + 24S + 1P	1-6450130-1
2.900	.250	.250	2.550	.875	2.950	-	3.250	.450	2P + 64S + 2P	1-6450130-0
2.550	.250	.300	1.825	1.125	2.600	-	2.900	.450	3P + 24S + 3ACP	6450130-9
2.675	.200	.200	2.375	1.650	2.725	-	3.025	.450	5P + 24S + 2P	6450130-8
3.650	.250	.250	2.550	1.875	3.700	-	4.000	.450	6P + 24S + 5P	6450130-7
2.400	.250	.250	1.800	1.125	2.450	-	2.750	.450	3P + 24S + 3P	6450130-6
4.350	.250	.250	3.500	2.625	4.400	-	4.700	.450	9P + 32S + 4P	6450130-5
2.800	.250	.300	2.075	1.375	2.850	-	3.150	.450	4P + 24S + 3ACP	6450130-4
3.050	.300	.250	1.950	1.275	3.100	-	3.400	.475	3ACP + 24S + 5P	6450130-3
2.550	.300	.250	2.200	1.525	2.600	-	2.900	.475	3ACP + 1P + 24S + 2P	6450130-2
3.650	.300	.250	2.550	1.275	3.700	-	4.000	.475	3ACP + 48S + 5P	6450130-1

(L8)	1.600	-	-	1.500	.625	1.650	-	1.950	.450	1P + 32S + 1P	9-6450130-9			
(L7)	2.400	.250	.250	1.550	.875	2.450	-	2.750	.450	2P + 24S + 4P	9-6450130-8			
(L5)	2.400	.250	.250	1.800	1.125	2.450	-	2.750	.450	3P + 24S + 3P	9-6450130-7			
(L3)	1.300	-	-	1.200	.625	1.350	-	1.650	.450	1P + 20S + 1P	9-6450130-6			
(K6)	2.300	.250	.300	1.575	.875	2.350	-	2.650	.450	2P + 24S + 3ACP	9-6450130-5			
	2.800	.250	.300	2.075	1.375	2.850	-	3.150	.450	4P + 24S + 3ACP	9-6450130-4			
	1.700	.250	.250	1.350	.875	1.750	-	2.050	.450	2P + 16S + 2P	9-6450130-3			
	DIM U	DIM S	△	DIM T	△	DIM R	DIM W	DIM D	DIM M	DIM L	△	DIM K	DESCRIPTION	PART NUMBER

THIS DRAWING IS A CONTROLLED DOCUMENT. DIMENSIONS: INCHES. TOLERANCES UNLESS OTHERWISE SPECIFIED: 0 PLC ±.01, 1 PLC ±.01, 2 PLC ±.01, 3 PLC ±.005, 4 PLC ±.002, ANGLES ±.020. MATERIAL: FINISH: THIS DRAWING IS A CONTROLLED DOCUMENT. DWG: R. GRZYBOWSKI, CHK: M. PERCHERKE, APVD: M. PERCHERKE. DATE: 4FEB2005. NAME: RIGHT ANGLE HEADER ASSEMBLY W/GUIDES MULTI-BEAM XL. PRODUCT SPEC: 108-1973. APPLICATION SPEC: 114-13038. WEIGHT: A100779. SCALE: 4:1. SHEET 2 OF 28. REV: M2. Customer Drawing.

PART NUMBER	ROWS	POWER				SIGNAL						POWER				
		P1	P2	P3	P4	1	2	3	4	5	6	P5	P6	P7		
6450130-4	D C B A	PM	PM	PM	PM	J	J	J	J	J	J	PM	PM	PM	HD	HD
						K	K	K	K	K	K					
						N	N	N	N	N	N					
						S	S	S	S	S	H					
4P + 24S + 3ACP																

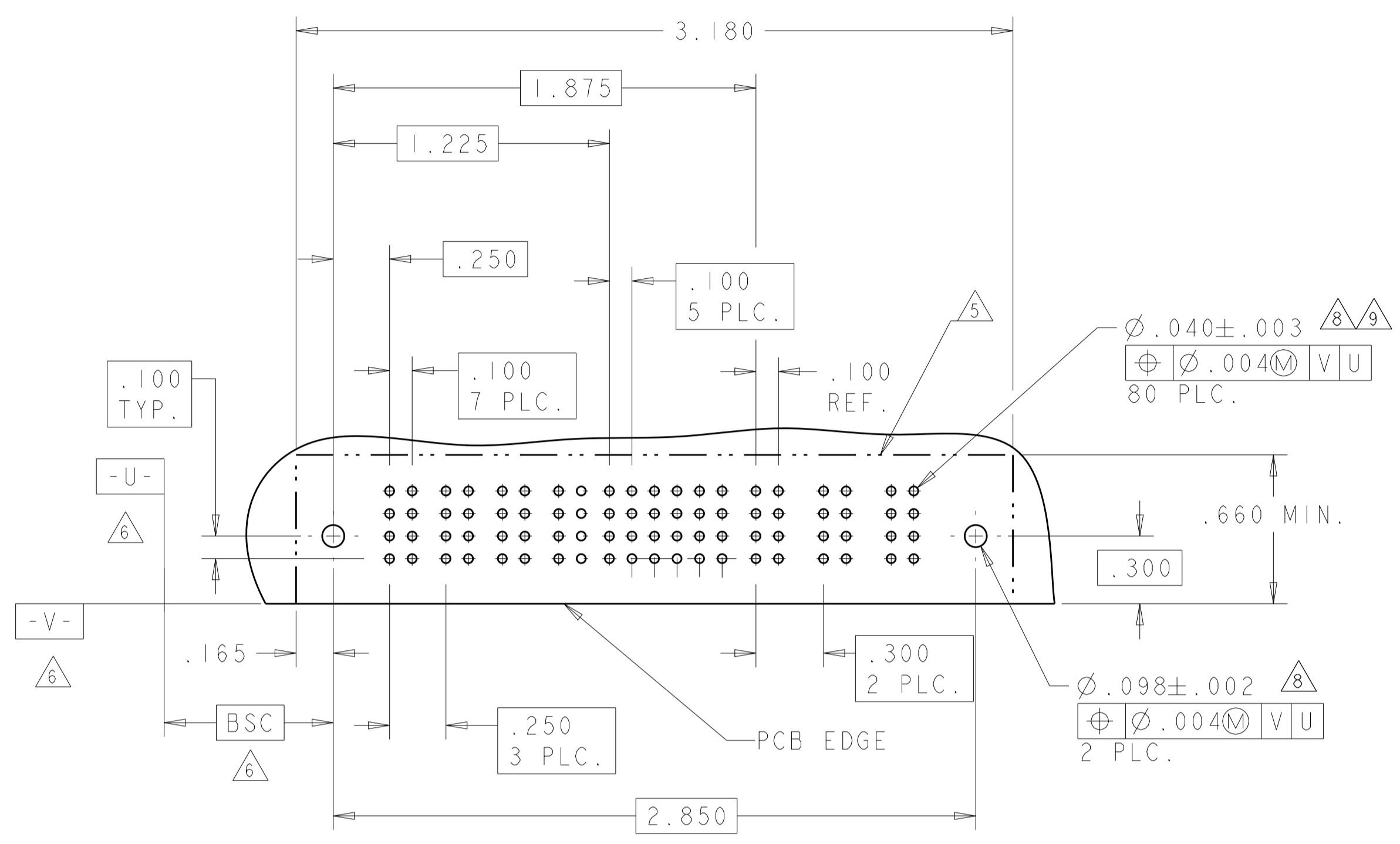

LOC	DIST	REV	DATE	APP'D
ES	00			

PART NUMBER	ROWS	POWER			SIGNAL						POWER				
		P1	P2	P3	1	2	3	4	5	6	P4	P5	P6		
6450130-6	D C B A	PM	PM	PM	J	J	J	J	J	J	PM	PM	PM	HD	HD
					K	K	K	K	K	K					
					N	N	G	N	N	N					
					S	S	S	S	S	S					
3P + 24S + 3P															

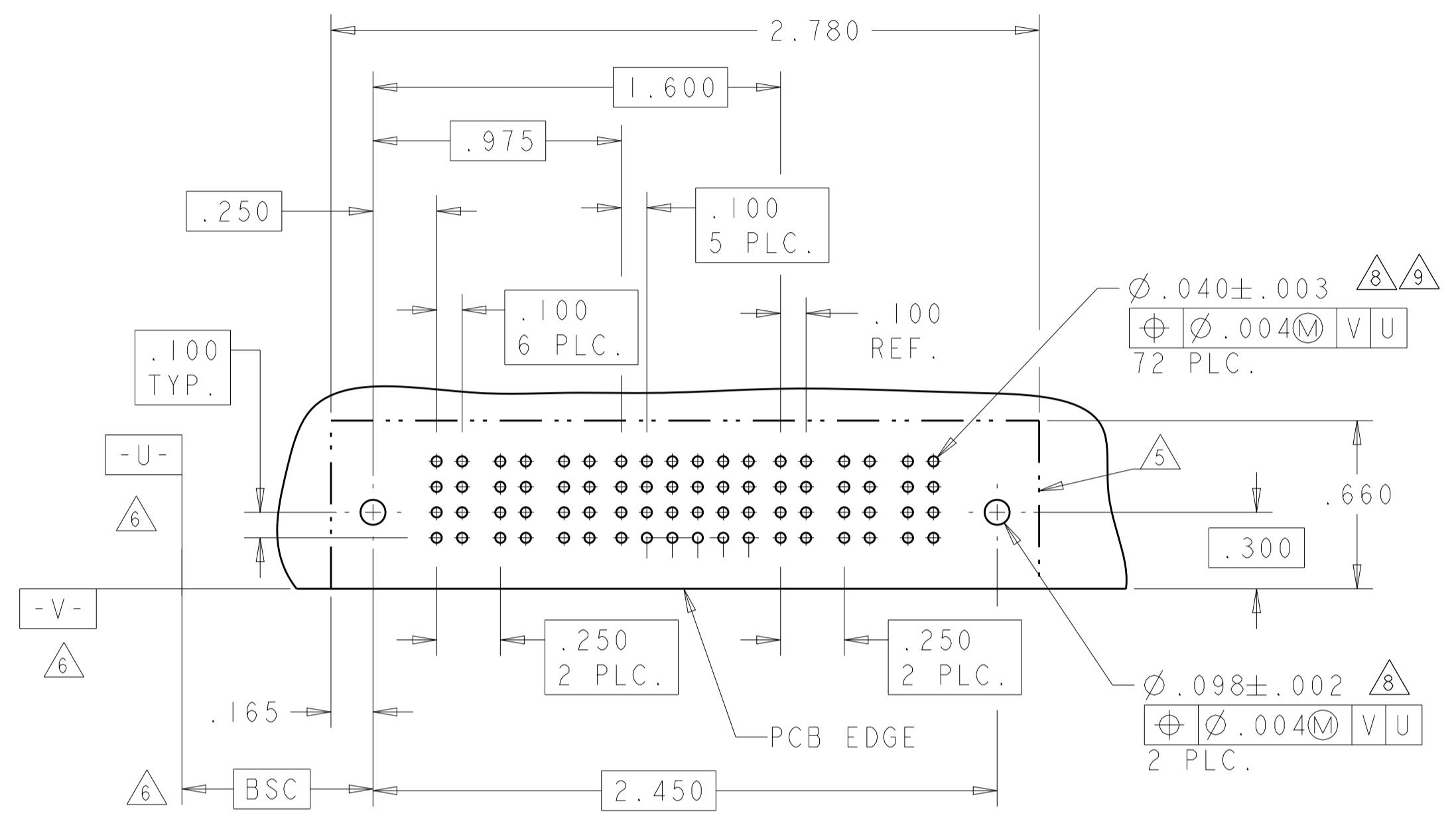

NO CONTACT LOADED

PART NUMBER	ROWS	POWER									SIGNAL								POWER					
		P1	P2	P3	P4	P5	P6	P7	P8	P9	1	2	3	4	5	6	7	8	P10	P11	P12	P13		
6450130-5	D C B A	PM	PM	PM	PM	PM	PM	PM	PM	PM	J	J	J	J	J	J	J	J	PM	PM	PM	PM	HD	HD
											K	K	K	K	K	K	K	K						
											N	N	N	N	N	N	N	N						
											S	S	S	S	S	S	S	S						
9P + 32S + 4P																								

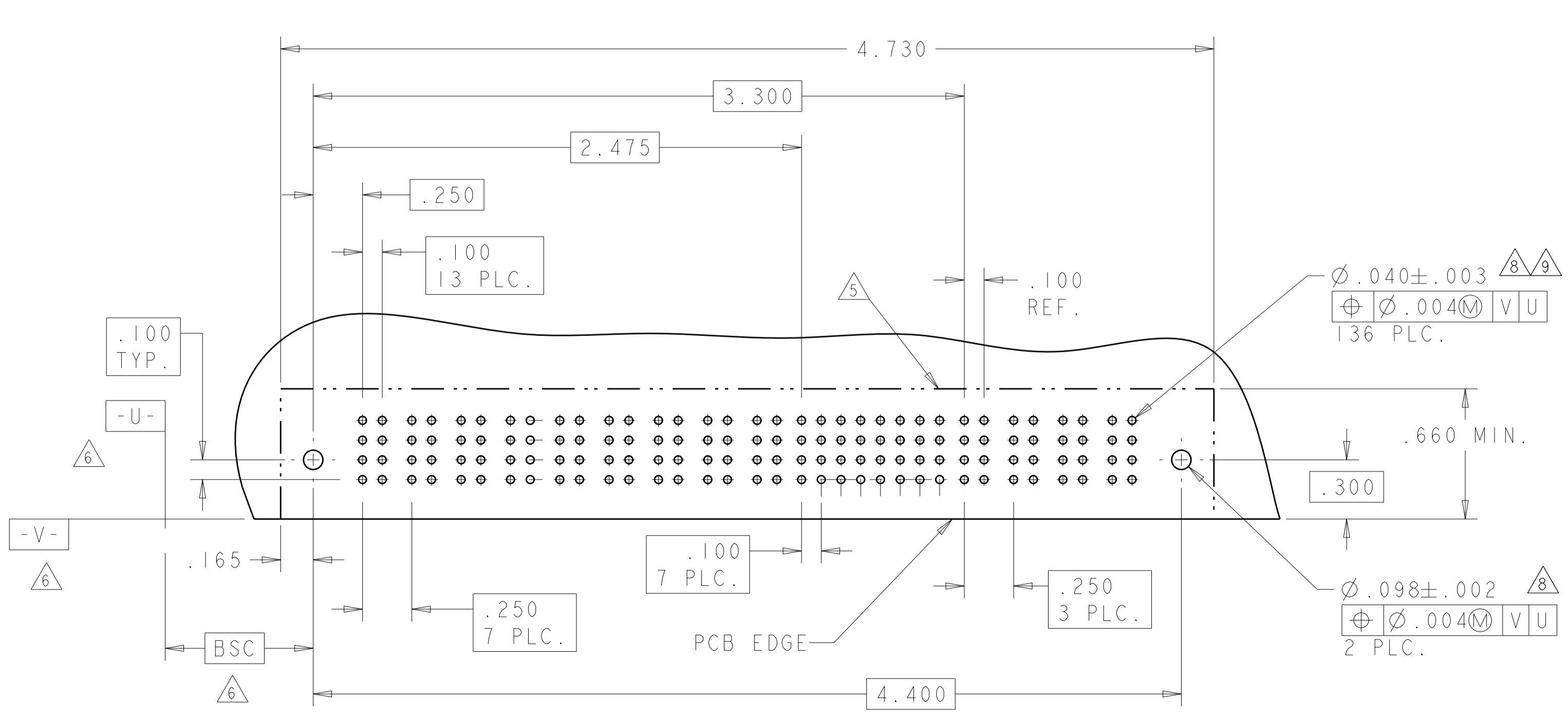

PART NUMBER	ROWS	POWER						SIGNAL						POWER						
		P1	P2	P3	P4	P5	P6	1	2	3	4	5	6	P7	P8	P9	P10	P11		
6450130-7	D C B A	PM	PM	PM	PM	PM	PM	J	J	J	J	J	J	PM	PM	PM	PM	PM	HD	HD
								K	K	F	K	K	K							
								N	N	N	N	N	G							
								S	S	H	S	S	S							
6P + 24S + 5P																				

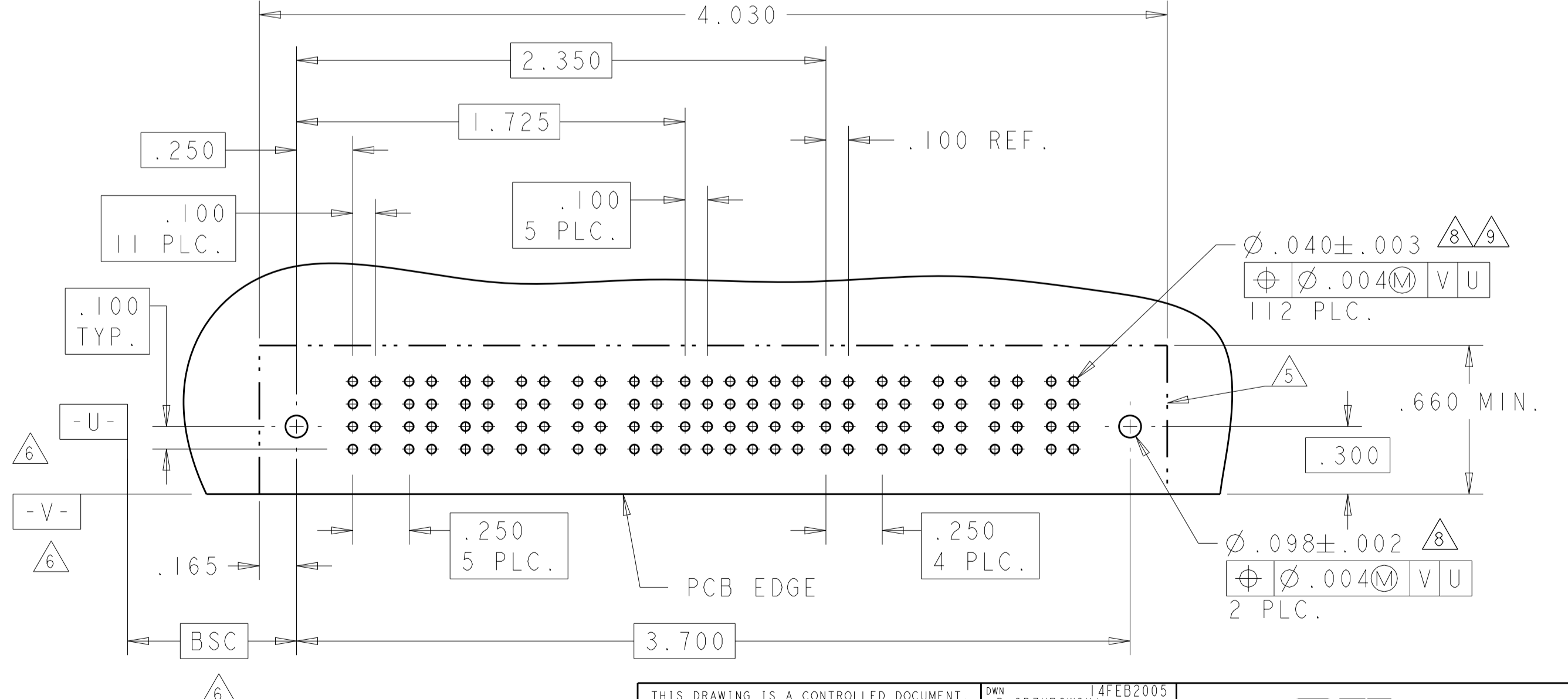

THIS DRAWING IS A CONTROLLED DOCUMENT.

DIMENSIONS: INCHES	TOLERANCES UNLESS OTHERWISE SPECIFIED:	OWN: R. GRZYBOWSKI 14FEB2005	CHK: M. PERCHERKE 14FEB2005	APVD: M. PERCHERKE 14FEB2005	NAME: RIGHT ANGLE HEADER ASSEMBLY W/GUIDES MULTI-BEAM XL
0 PLC ±.01	1 PLC ±.005	PRODUCT SPEC: 108-1973	APPLICATION SPEC: 114-13038	WEIGHT: A100779	SCALE: 4:1
1 PLC ±.002	2 PLC ±.001	SIZE: 114-13038	CAGE CODE: 6450130	DRAWING NO: 100779	SHEET 4 OF 28
2 PLC ±.001	3 PLC ±.0005	REVISIONS: SEE SHEET 1	DATE: -	APP'D: -	REV: M2

Customer Drawing

PART NUMBER	ROWS	POWER			SIGNAL				POWER	
		P1	P2	P3	1	2	3	4	P4	P5
3-6450130-9	D C B A	PM	PM	PM	J	J	J		PM	PM
					K	K	K			
					N	N	N			
					S	S	H			

3ACP + 16S + 2P
CONTACTS NOT LOADED

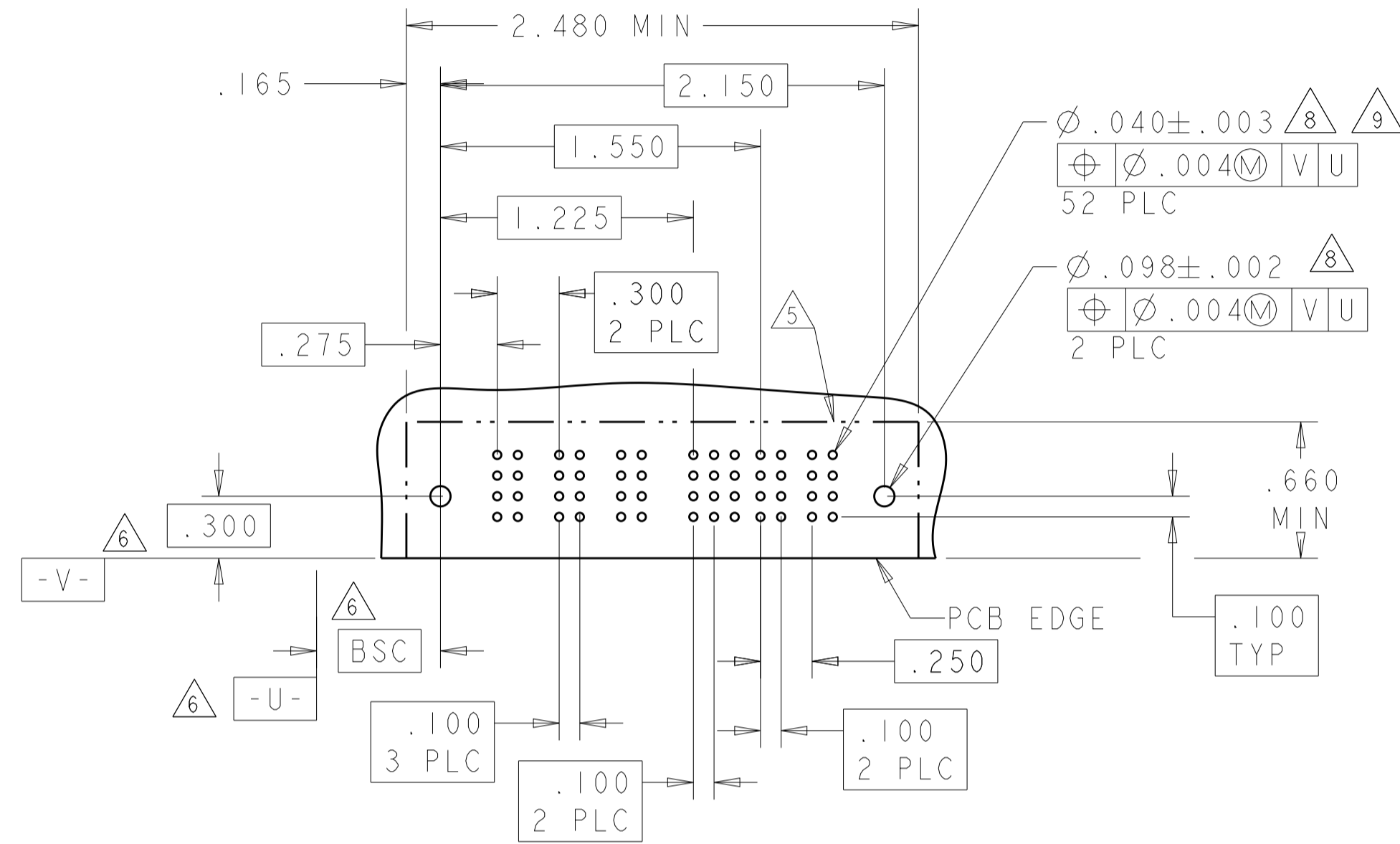

PART NUMBER	ROWS	POWER				SIGNAL				POWER			
		P1	P2	P3	P4	1	2	P5	P6	P7	P8		
4-6450130-0	D C B A	PA	PA	PA	PA	Z	Z	PA	PA	PA	PA		
						Y	Y						
						R	R						
						O	O						

4P + 8S + 4P

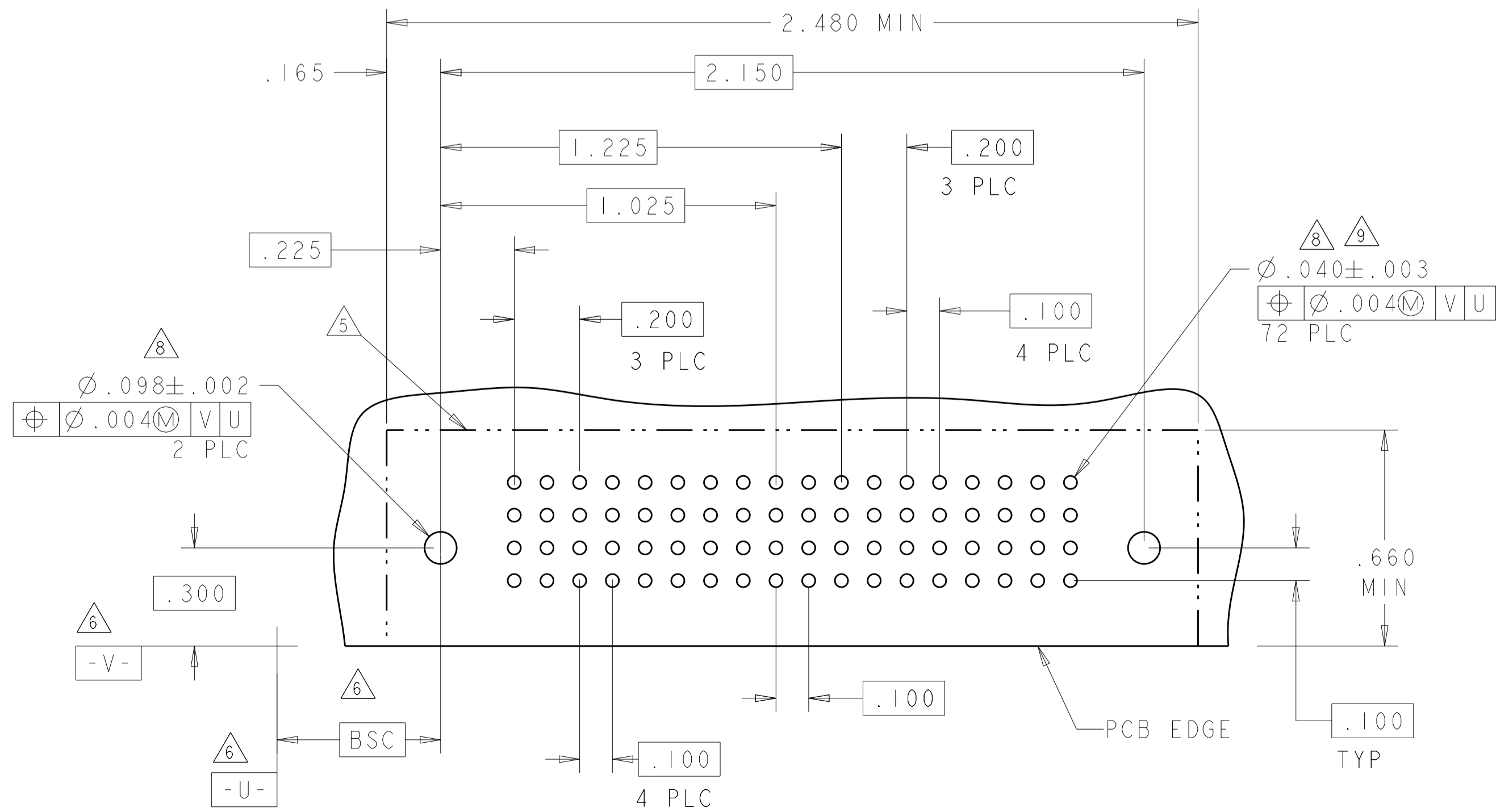

PART NUMBER	ROWS	POWER			SIGNAL				POWER	
		P1	P2	P3	1	2	3	4	P4	P5
4-6450130-3	D C B A			PM	J	J	J		PM	PM
					K	K	K			
					N	N	N			
					S	S	H			

3ACP + 16S + 2P

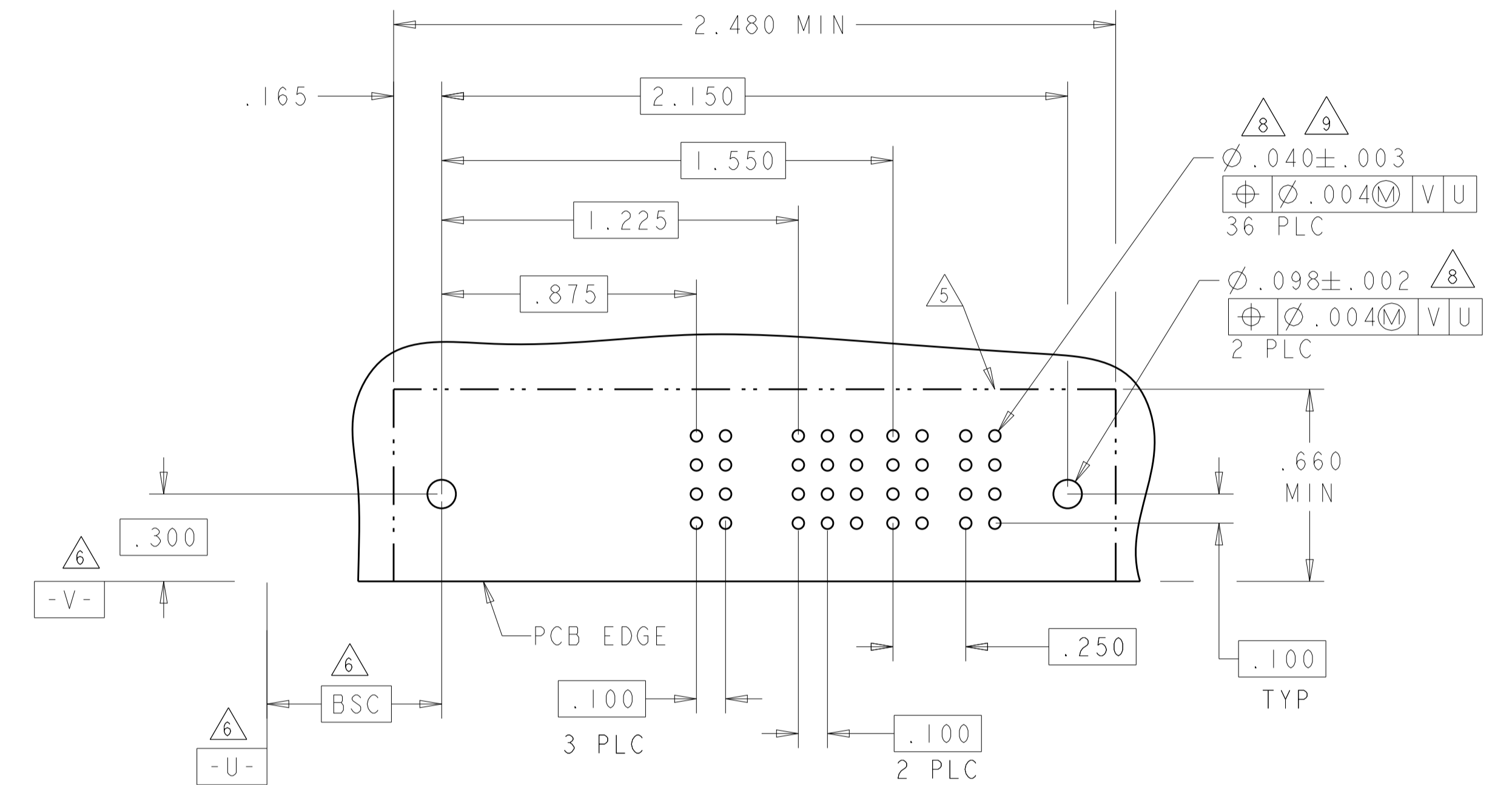

PART NUMBER	ROWS	POWER					SIGNAL								POWER				
		P1	P2	P3	P4	P5	1	2	3	4	5	6	7	8	P6	P7	P8	P9	P10
4-6450130-5	D C B A	PM	PM	PM	PM	PM	J	J	J	J	J	J	J	J	PM	PM	PM	PM	PM
							K	K	K	K	K	K	K	K					
							N	N	N	N	N	N	N	N					
							H	H	H	H	H	H	H	H					

5P + 32S + 5P

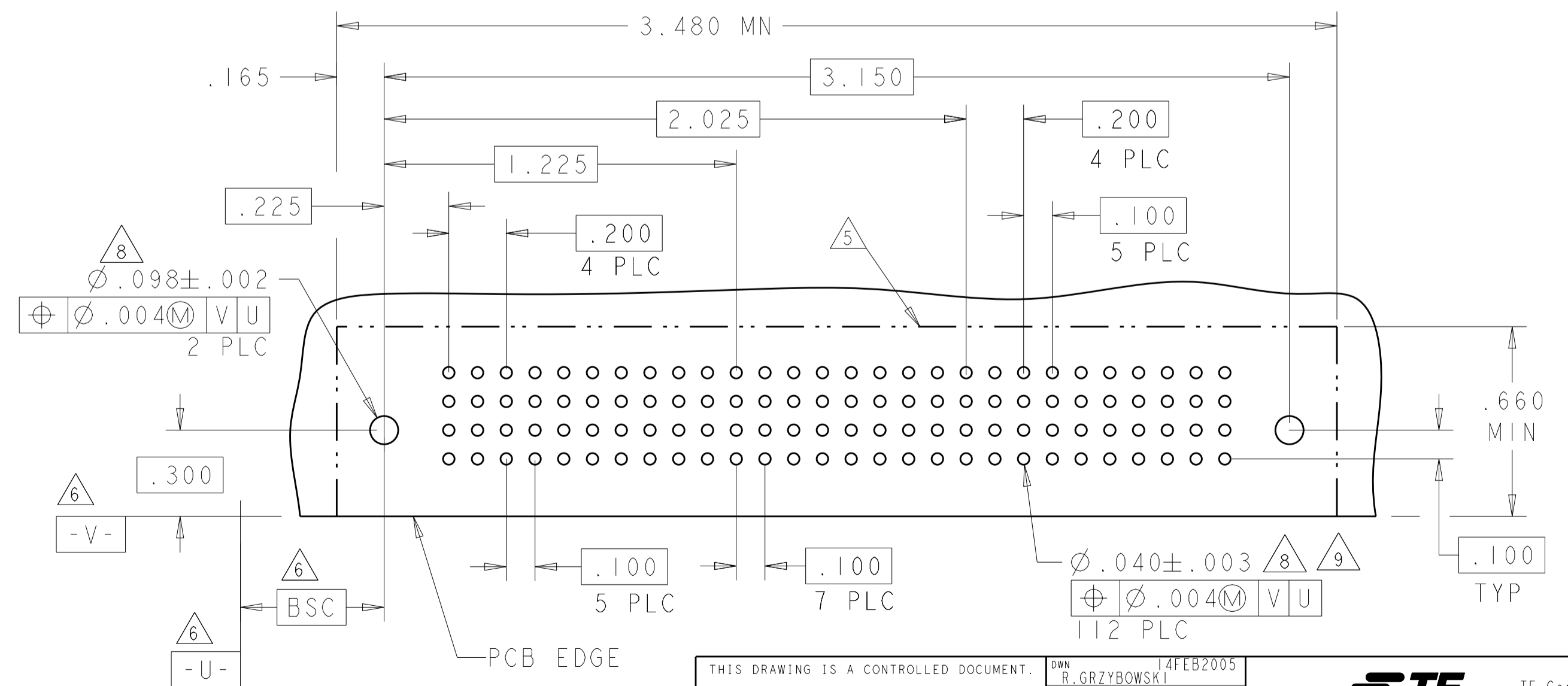

THIS DRAWING IS A CONTROLLED DOCUMENT.

DIMENSIONS: INCHES 	TOLERANCES UNLESS OTHERWISE SPECIFIED: 0 PLC ±. 1 PLC ±.01 2 PLC ±.01 3 PLC ±.005 4 PLC ±.002 ANGLES ±.020	DWN: R. GRZYBOWSKI 14FEB2005 CHK: M. PERCHERKE 14FEB2005 APVD: M. PERCHERKE 14FEB2005 PRODUCT SPEC 108-1973 APPLICATION SPEC 114-13038 WEIGHT Customer Drawing	NAME: RIGHT ANGLE HEADER ASSEMBLY W/GUIDES MULTI-BEAM XL SIZE: A1 CAGE CODE: 100779 DRAWING NO: C=6450130 SCALE: 4:1 SHEET: 10 OF 28 REV: M2
---------------------------	--	--	--

STC TE Connectivity

PART NUMBER	ROWS	POWER					SIGNAL					POWER	
		P1	P2	P3	P4	P5	1	2	3	4	5	P6	P7
7-6450130-9	D C B A	PM	PM	PM	PM	PM	J	J	J	J	J	PM	PM
							K	K	K	K	K		
							N	G	N	N	N		
							S	S	S	S	S		
5P + 20S + 2P													

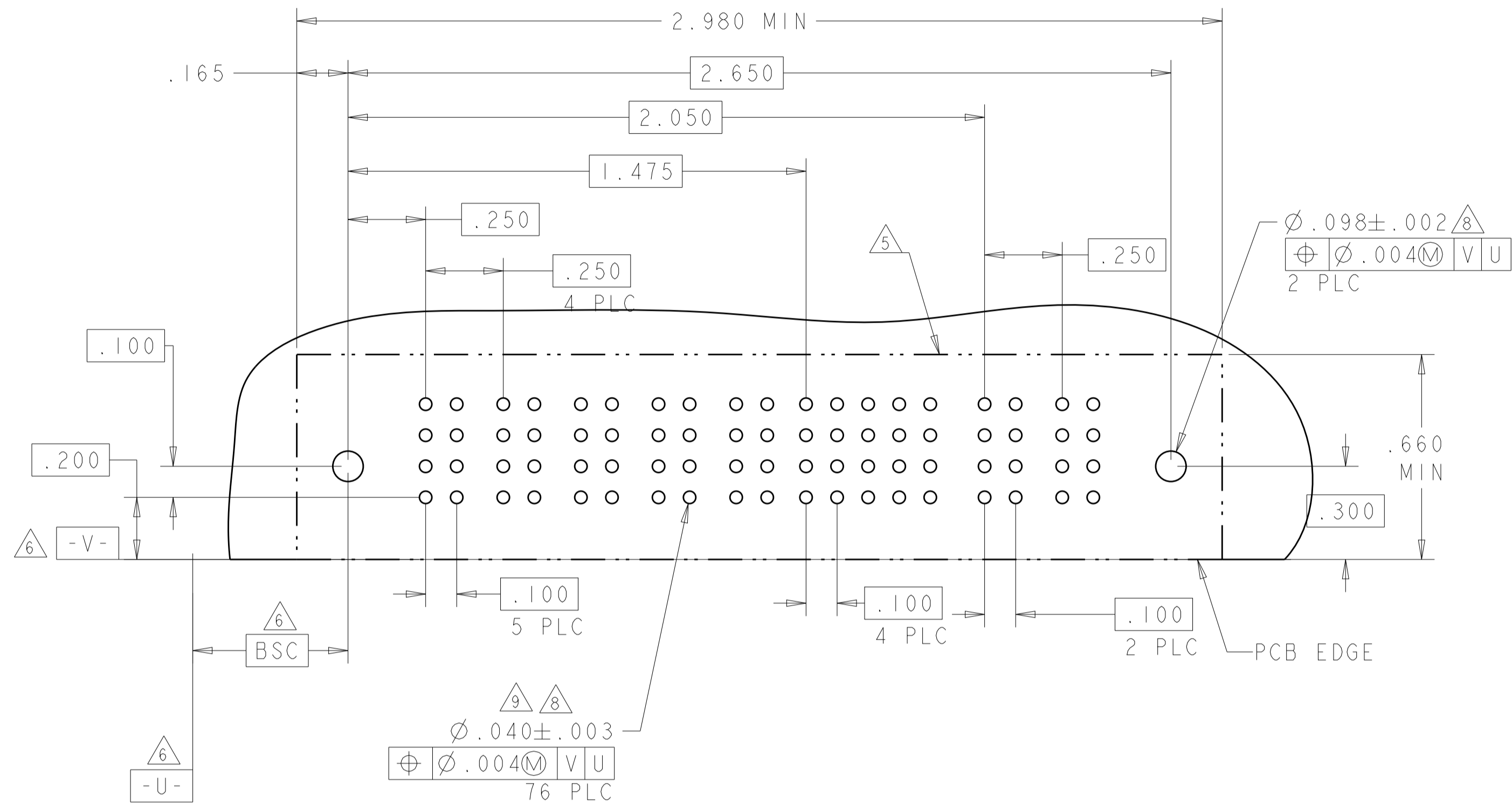

LOC	DIST	REV	DATE	BY	APPV
ES	00				

PART NUMBER	ROWS	POWER						SIGNAL					POWER	
		P1	P2	P3	P4	P5	P6	1	2	3	4	5	P7	P8
8-6450130-0	D C B A	PM	PM	PM	PM	PM	J	J	J	J	J	PM	PM	
							K	K	K	K	K			
							N	G	N	N	N			
							S	S	S	S	S			
6P + 20S + 2P														

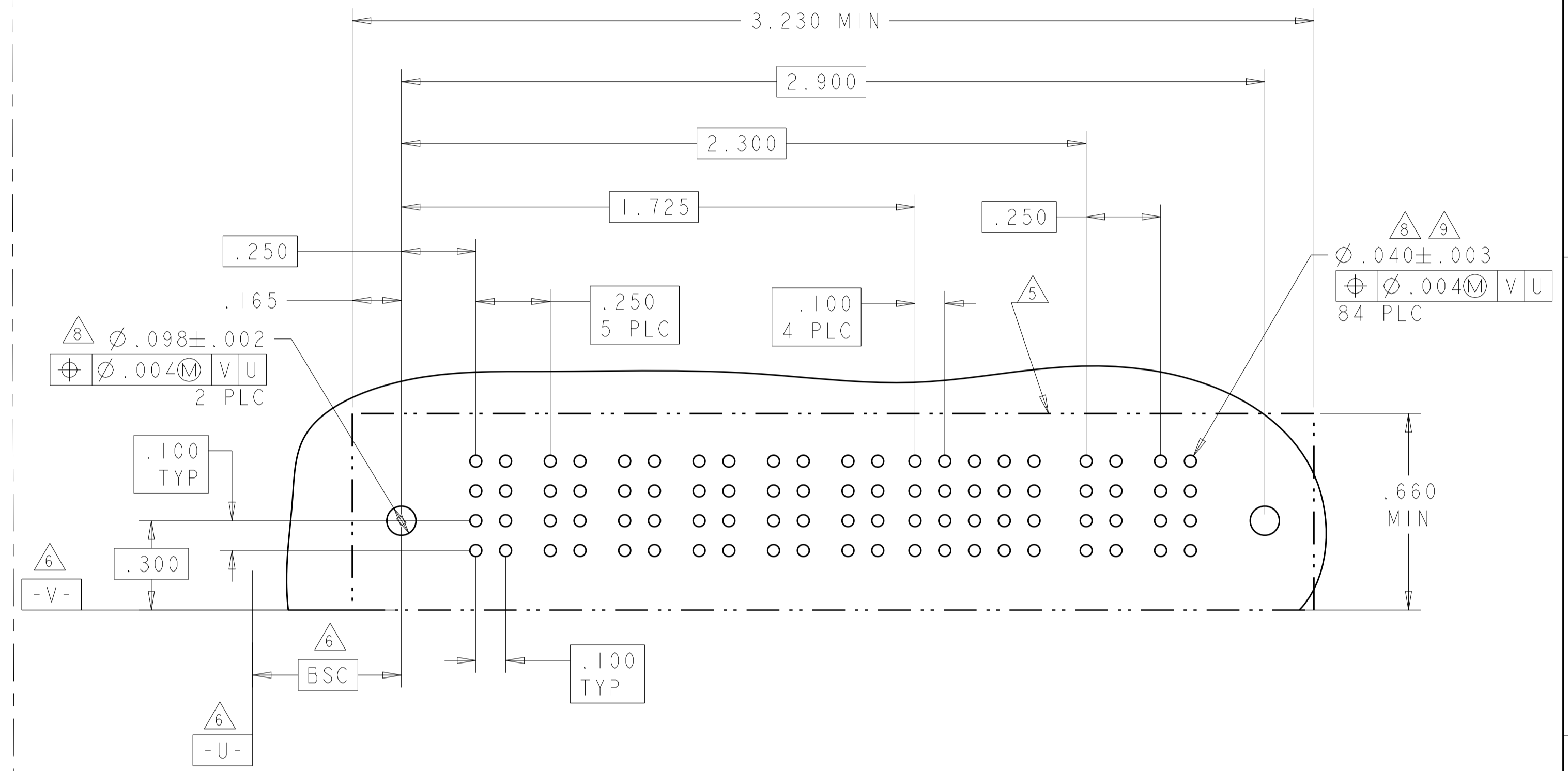

PART NUMBER	ROWS	POWER			SIGNAL						POWER				
		P1	P2	P3	1	2	3	4	5	6	P4	P5	P6	P7	P8
7-6450130-6	D C B A	PM	PM	PM							PM	PM	PM	PM	PM
					J	J	J	J	J						
					K	K	K	K	K						
					N	N	N	N	N						
3ACP + 24S + 5P															

NO CONTACTS LOADER

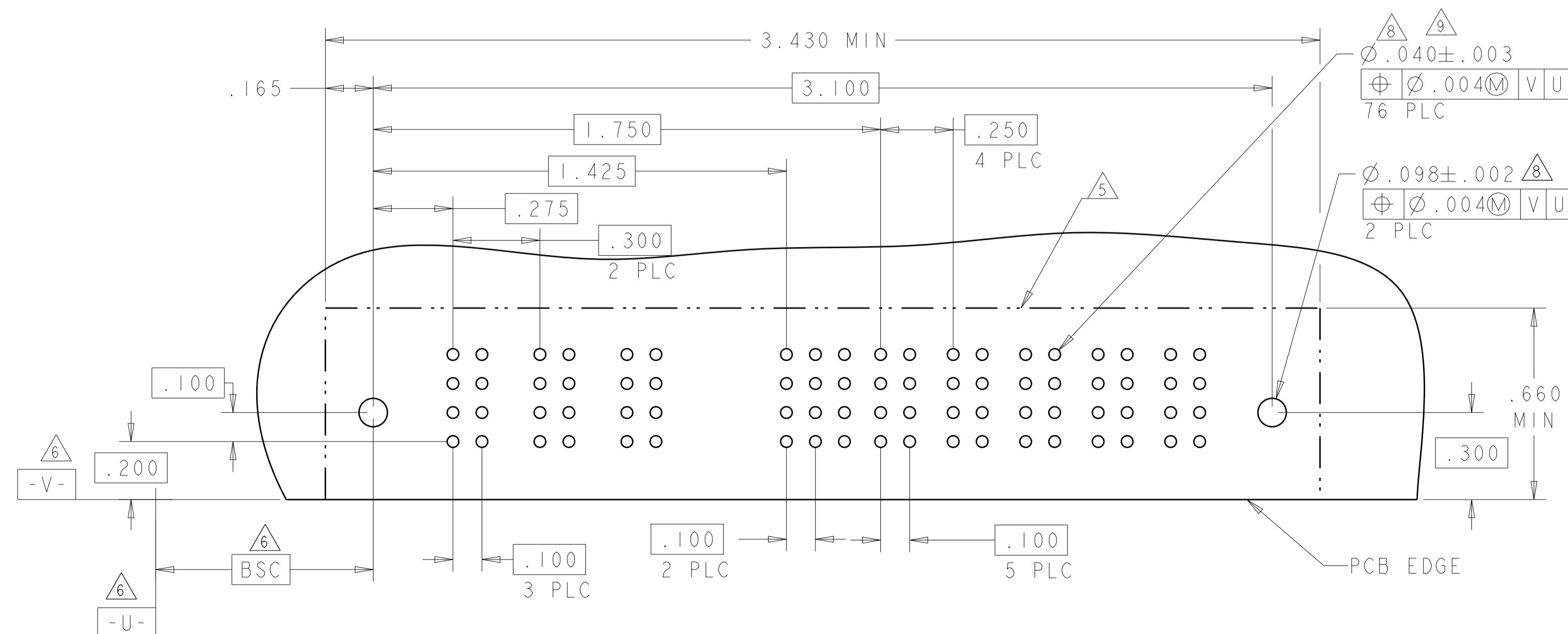

PART NUMBER	ROWS	POWER				SIGNAL						POWER		
		P1	P2	P3	P4	1	2	3	4	5	6	P5	P6	P7
8-6450130-2	D C B A	PM	PM	PM	PM	J	J	J	J	J	J	PM	PM	PM
						K	K	K	K	K	K			
						N	N	N	N	N	N			
						S	S	S	S	S	H			
4P + 24S + 3ACP														

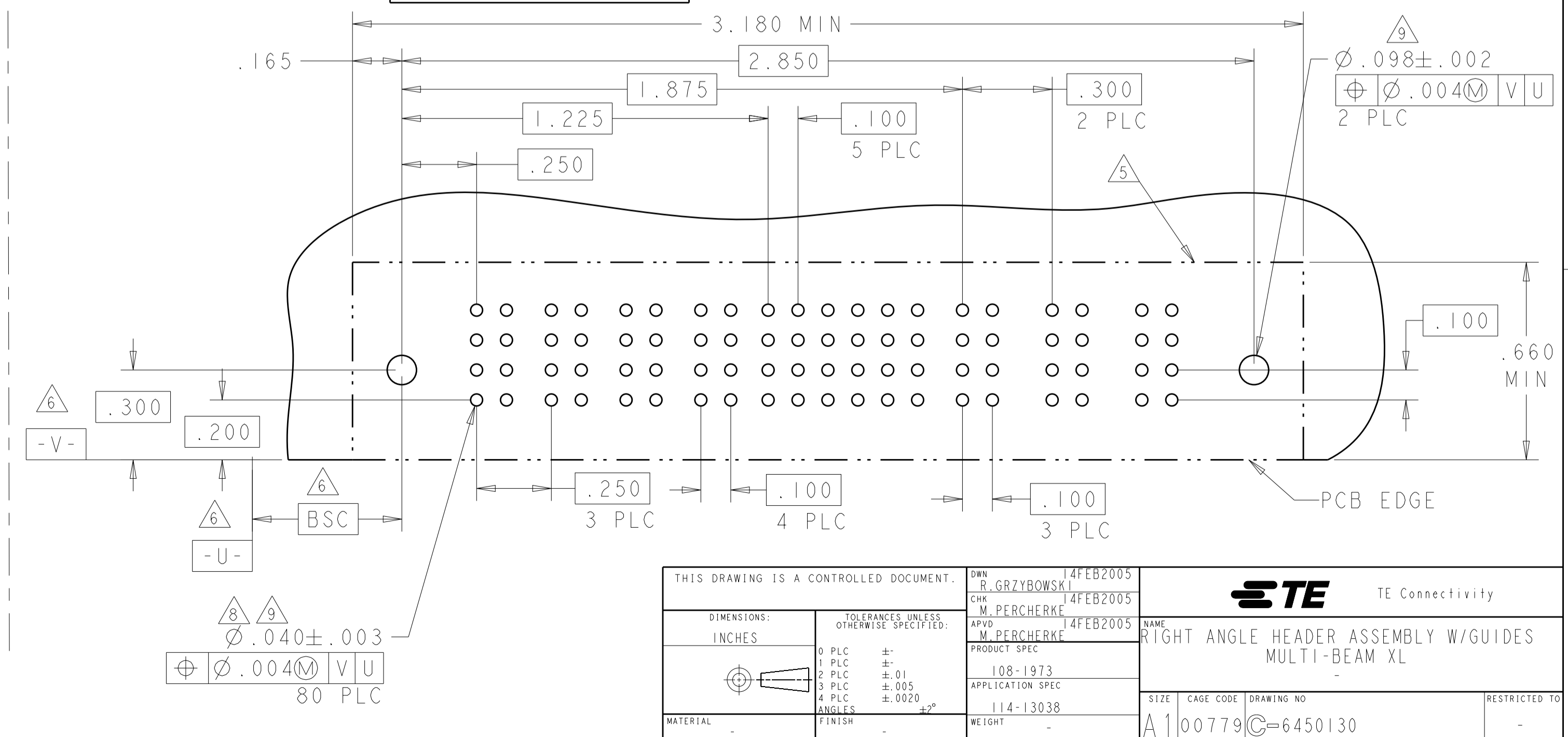

THIS DRAWING IS A CONTROLLED DOCUMENT.

<p>OWNER: R. GRZYBOWSKI 14FEB2005</p> <p>CHK: M. PERCHERKE 14FEB2005</p> <p>APPV: M. PERCHERKE 14FEB2005</p> <p>PRODUCT SPEC: 108-1973</p> <p>APPLICATION SPEC: 114-13038</p> <p>WEIGHT: A100779</p> <p>Customer Drawing</p>	<p>NAME: RIGHT ANGLE HEADER ASSEMBLY W/GUIDES MULTI-BEAM XL</p> <p>SIZE: CAGE CODE DRAWING NO: 6450130</p> <p>RESTRICTED TO: M2</p>	<p>SCALE: 4:1</p> <p>SHEET: 13 OF 28</p> <p>REV: M2</p>
--	---	---

LOC	DIST	REVISIONS			
P	LTN	DESCRIPTION	DATE	OWN	APVD
-	-	SEE SHEET 1	-	-	-

PART NUMBER	ROWS	POWER		SIGNAL				POWER	
		P1	P2	1	2	3	4	P3	P4
8-6450130-9	D	PM	PM	J	J	J	J	PM	PM
	C			K	K	F	K		
	B			N	N	G	N		
	A			S	S	S	S		

IP + 16S + IP

PART NUMBER	ROWS	POWER		SIGNAL						POWER	
		P1	P2	1	2	3	4	5	6	P3	P4
2-6450130-9	D	PM	PM	J	J	J	J	J	J	PM	PM
	C			K	K	K	K	F			
	B			N	N	N	N	N			
	A			S	S	S	S	S			

2P + 24S + 2P

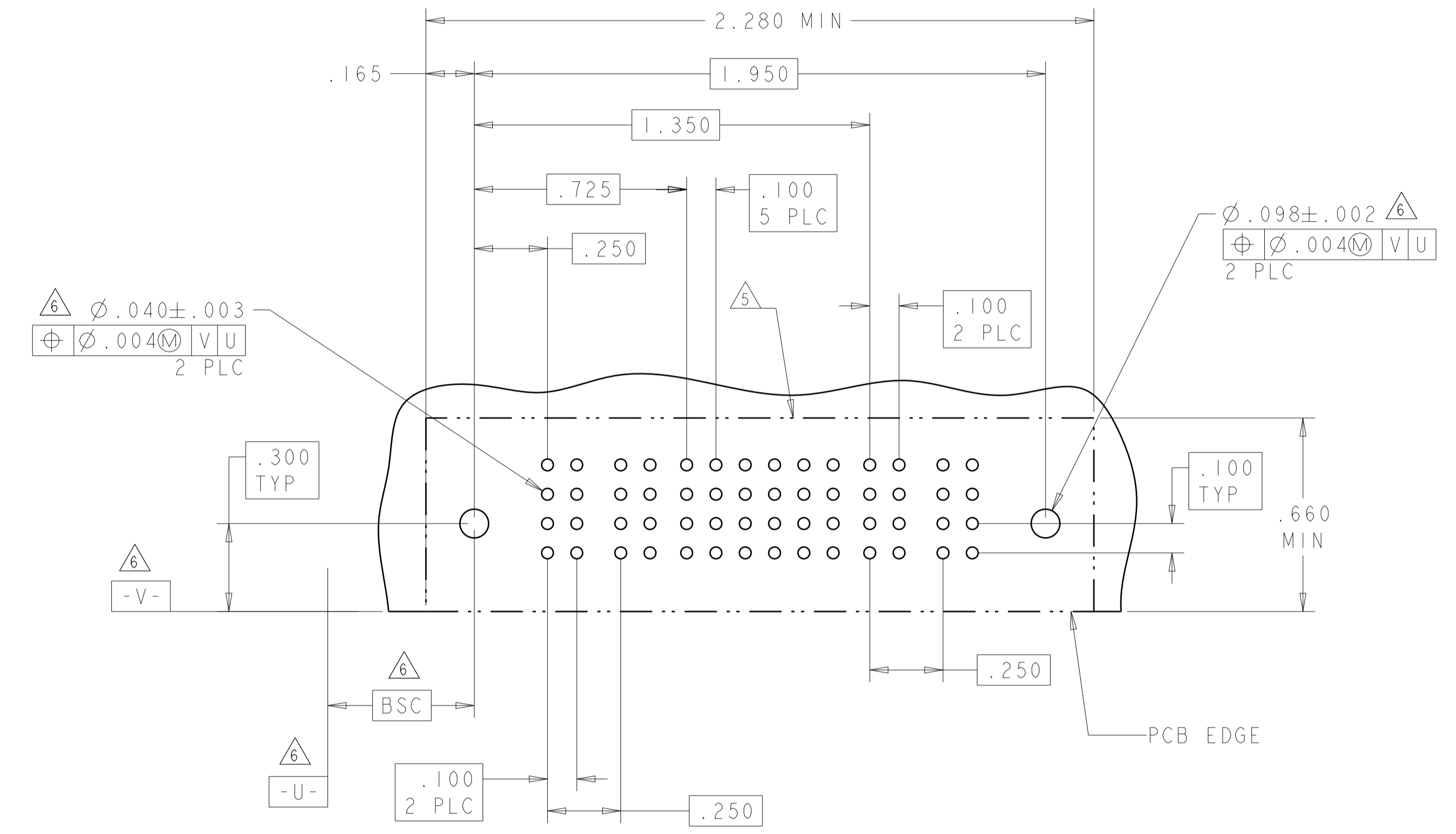
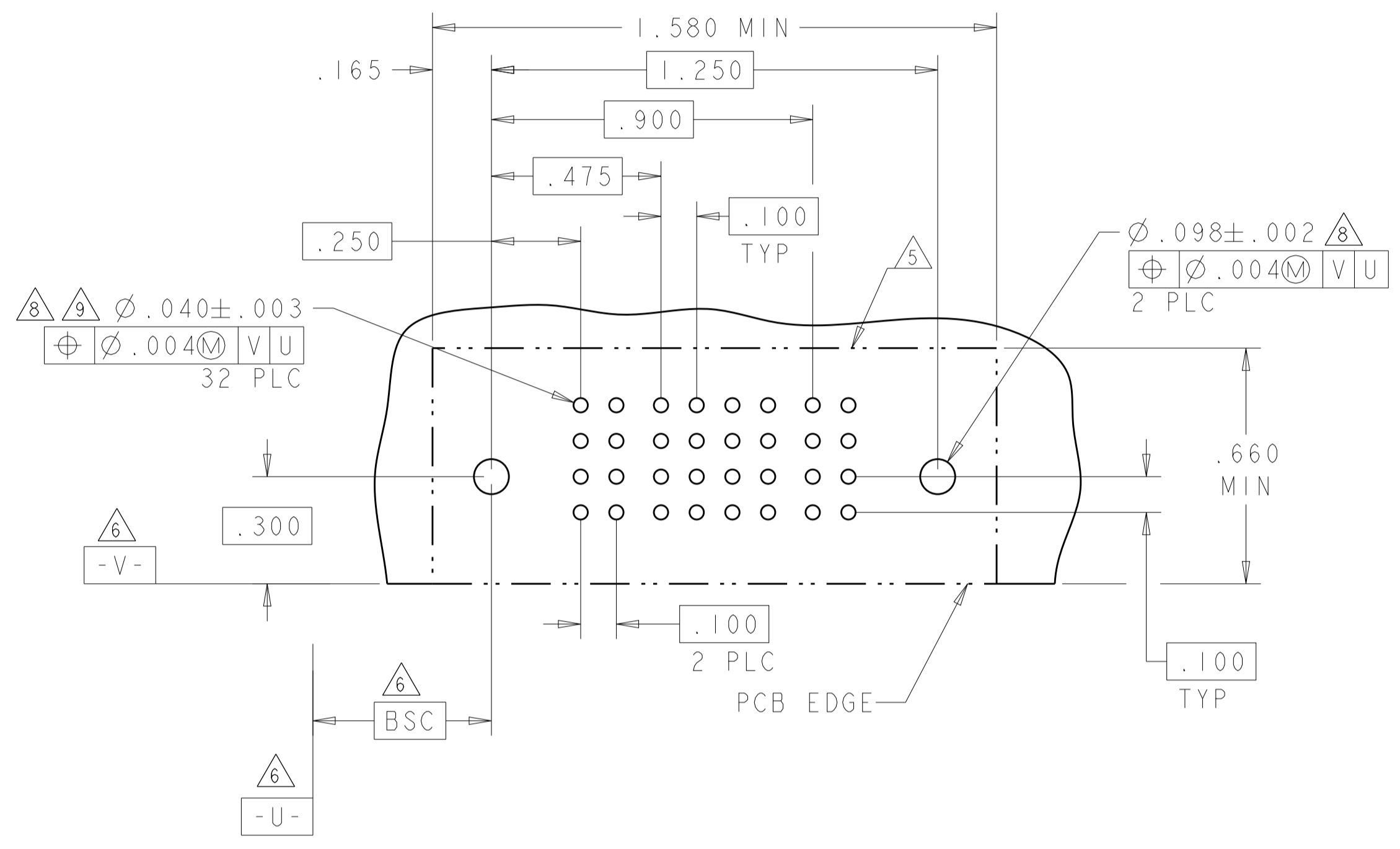

THIS DRAWING IS A CONTROLLED DOCUMENT.		OWN: R. GRZYBOWSKI 14FEB2005	TE Connectivity														
DIMENSIONS: INCHES		CHK: M. PERCHERKE 14FEB2005															
TOLERANCES UNLESS OTHERWISE SPECIFIED:		APVD: M. PERCHERKE 14FEB2005	NAME: RIGHT ANGLE HEADER ASSEMBLY W/GUIDES MULTI-BEAM XL														
<table border="1"> <tr><td>0 PLC</td><td>±</td></tr> <tr><td>1 PLC</td><td>±.01</td></tr> <tr><td>2 PLC</td><td>±.005</td></tr> <tr><td>3 PLC</td><td>±.002</td></tr> <tr><td>4 PLC</td><td>±.002</td></tr> <tr><td>ANGLES</td><td>±.002</td></tr> <tr><td>FINISH</td><td>±.002</td></tr> </table>		0 PLC	±	1 PLC	±.01	2 PLC	±.005	3 PLC	±.002	4 PLC	±.002	ANGLES	±.002	FINISH	±.002	PRODUCT SPEC: 108-1973	SIZE: A1
0 PLC	±																
1 PLC	±.01																
2 PLC	±.005																
3 PLC	±.002																
4 PLC	±.002																
ANGLES	±.002																
FINISH	±.002																
MATERIAL: -		APPLICATION SPEC: 114-13038	CAGE CODE: C=6450130														
WEIGHT: -		Customer Drawing	SCALE: 4:1 SHEET 16 OF 28 REV: M2														

LOC		DIST		REVISIONS				
P	LTN	DATE	DMN	APVD	DESCRIPTION			
-	-	-	-	-	SEE SHEET 1			

PART NUMBER	ROWS	POWER		SIGNAL			POWER					
		P1	P2	1	2	3	P3	P4	P5	P6	P7	
9-6450130-2	D	PM	PM	J	J	J	PM	PM	PM	PM	PM	
	C			K	K	K						
	B			N	N	N						
	A			S	S	S						
2P + 12S + 5P												

(K2)

PART NUMBER	ROWS	POWER				SIGNAL							POWER			
		P1	P2	P3	P4	1	2	3	4	5	6	7	P5	P6	P7	P8
2-6450130-4	D	PA	PA	PA	PA	A4	A4	A4	A4	A4	A4	A4	PA	PA	PA	PA
	C					A3	A3	A3	A3	A3	A3					
	B					A2	A2	A2	A2	A2	A2					
	A					A1	A1	A1	A1	A1	A1					
4HDP + 28S + 4HDP																

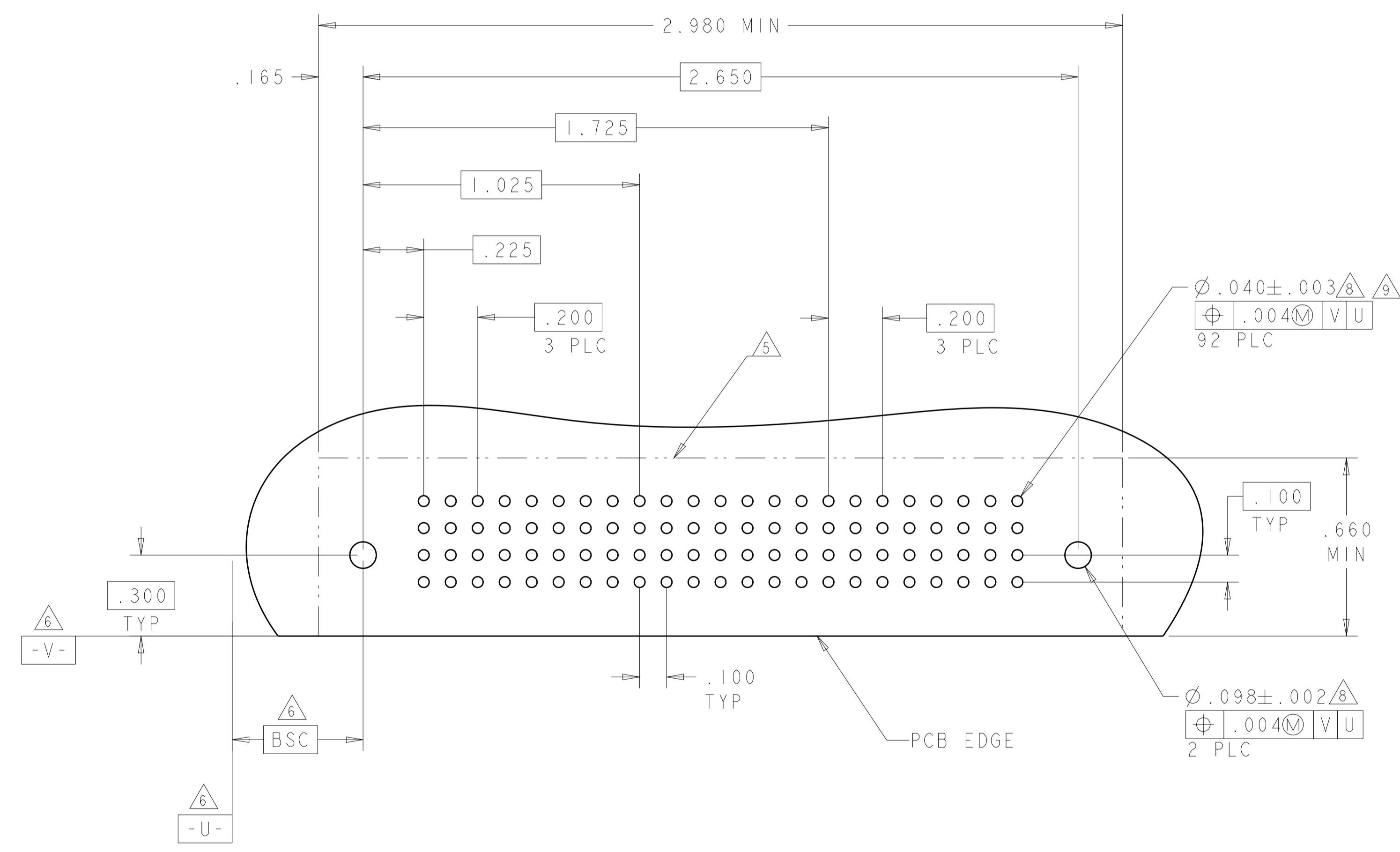
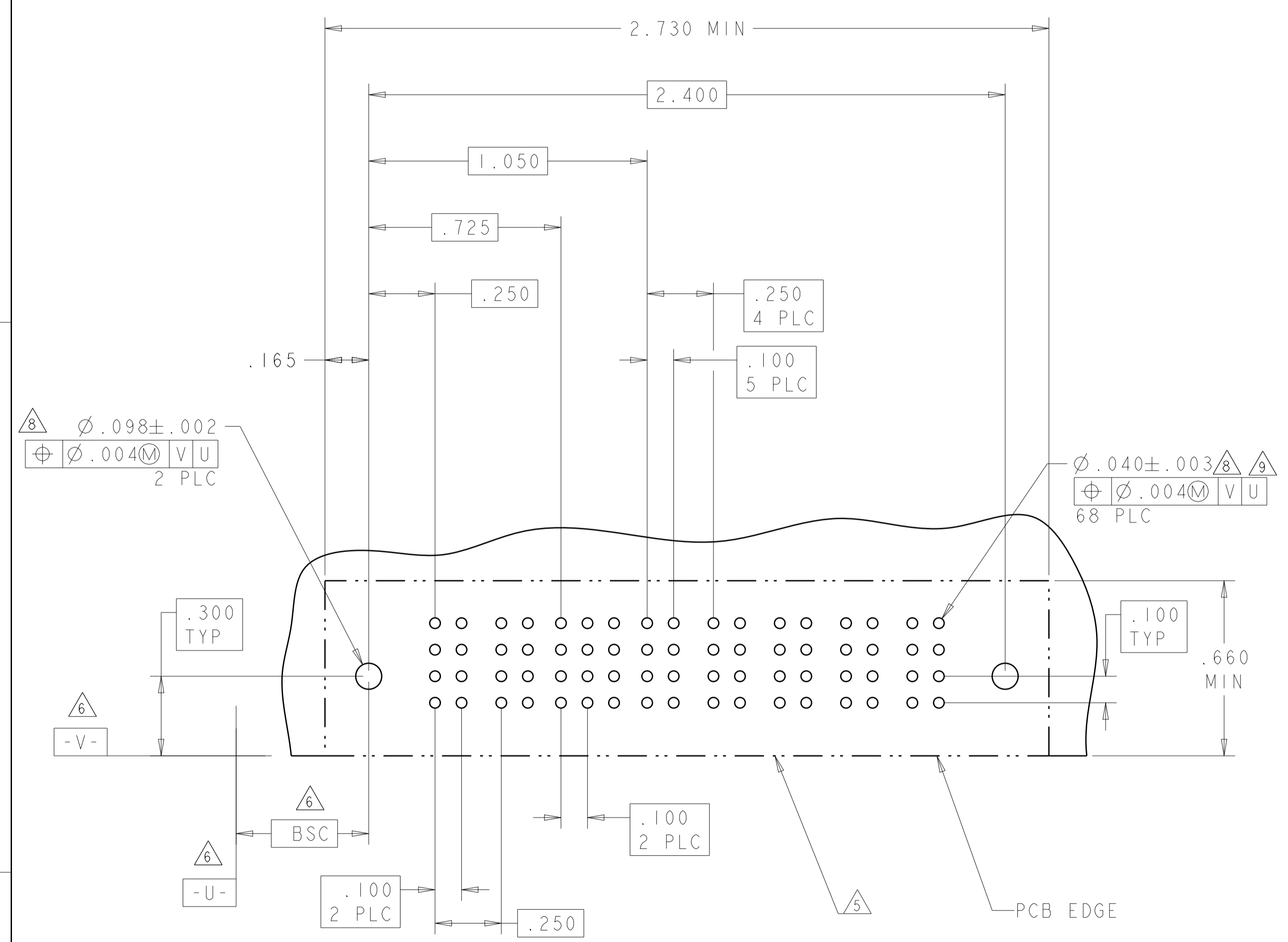

THIS DRAWING IS A CONTROLLED DOCUMENT. DWG: R.GRZYBOWSKI 14FEB2005
 CHK: M.PERCHEKKE 14FEB2005
 APVD: M.PERCHEKKE 14FEB2005

STE TE Connectivity

NAME: RIGHT ANGLE HEADER ASSEMBLY W/GUIDES MULTI-BEAM XL

PRODUCT SPEC: 108-1973
 APPLICATION SPEC: 114-13038

SIZE: A1 CAGE CODE: 6450130 DRAWING NO: 100779
 WEIGHT: -

Customer Drawing SCALE: 4:1 SHEET: 18 OF 28 REV: M2

LOC	DIST	REVISIONS			
P	LTN	DESCRIPTION	DATE	OWN	APVD
-	-	SEE SHEET 1	-	-	-

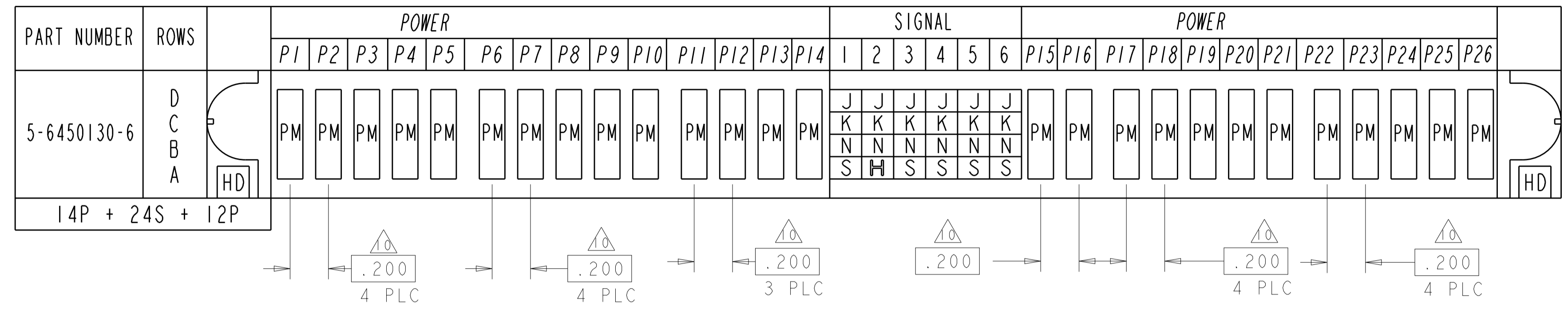

L2

L6

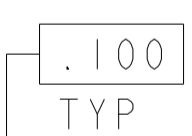
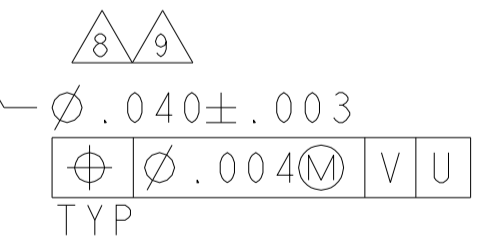
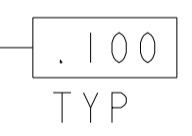
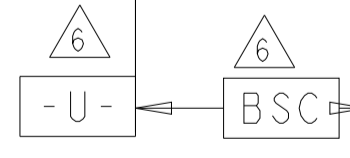
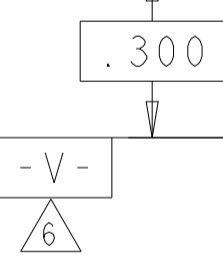
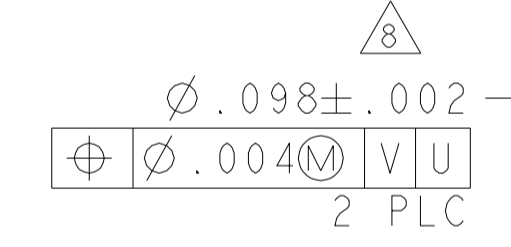

THIS DRAWING IS A CONTROLLED DOCUMENT.

DIMENSIONS: INCHES	TOLERANCES UNLESS OTHERWISE SPECIFIED: 0 PLC ±. 1 PLC ±.01 2 PLC ±.01 3 PLC ±.005 4 PLC ±.0020 ANGLES ±.7°	OWN: R. GRZYBOWSKI 14FEB2005 CHK: M. PERCHERKE 14FEB2005 APVD: M. PERCHERKE 14FEB2005	NAME: RIGHT ANGLE HEADER ASSEMBLY W/GUIDES MULTI-BEAM XL
MATERIAL: .	FINISH: .	PRODUCT SPEC: 108-1973 APPLICATION SPEC: 114-13038 WEIGHT: .	SIZE: A1 CAGE CODE: 100779 DRAWING NO: C=6450130 RESTRICTED TO: .
Customer Drawing		SCALE: 4:1	SHEET 21 OF 28 REV: M2

4805 (3/11)

LOC	DIST	REVISIONS					
		P	LTN	DESCRIPTION	DATE	DWN	APVD
ES	00	-	-	SEE SHEET 1	-	-	-

PART NUMBER	ROWS	POWER		SIGNAL						POWER		
		P1	P2	1	2	3	4	5	6	P3	P4	P5
9-6450130-5	D	PM	PM	J	J	E	J	J	J	PM	PM	PM
	C			K	K	K	K	K				
	B			N	N	G	N	N	N			
	A			S	S	S	S	S	S			

2P + 24S + 3ACP

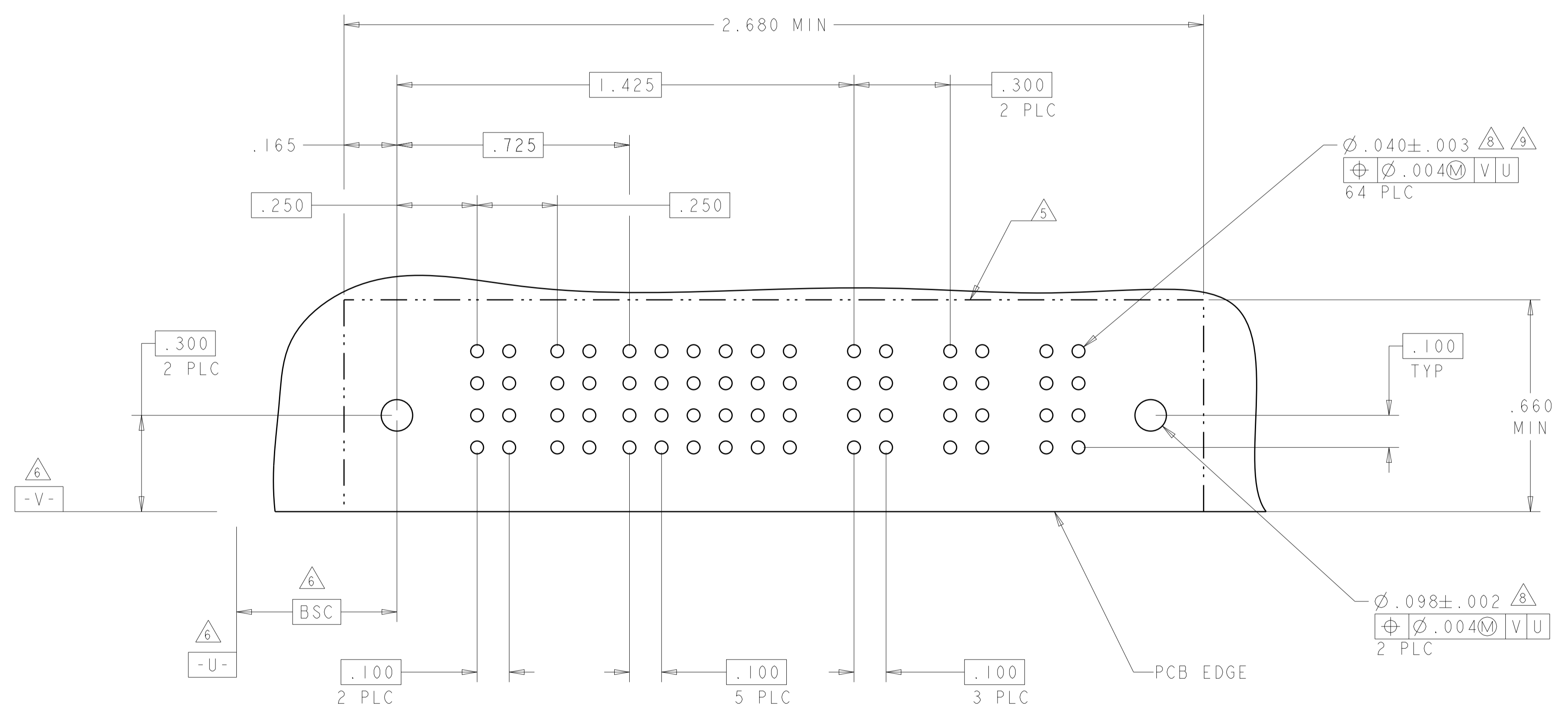

DIMENSIONS:		TOLERANCES UNLESS OTHERWISE SPECIFIED:	
INCHES		0 PLC	±
		1 PLC	±.01
		2 PLC	±.01
		3 PLC	±.005
		4 PLC	±.0020
		ANGLES	±.2°
		FINISH	

THIS DRAWING IS A CONTROLLED DOCUMENT.		DWN: R. GRZYBOWSKI 14FEB2005	CHK: M. PERCHERKE 14FEB2005	APVD: M. PERCHERKE 14FEB2005
MATERIAL: -		NAME: RIGHT ANGLE HEADER ASSEMBLY W/GUIDES MULTI-BEAM XL		
WEIGHT: -		SIZE: A1	CAGE CODE: 114-13038	DRAWING NO: 6450130
Customer Drawing		SCALE: 4:1	SHEET: 22	OF: 28

LOC	DIST	REV	DATE	BY	APPV
ES	00				
REVISIONS			DESCRIPTION	DATE	BY
			SEE SHEET 1		

PART NUMBER	ROWS	POWER		SIGNAL												POWER			
		P1	P2	1	2	3	4	5	6	7	8	9	10	11	12	P3	P4		
6-6450130-9	D	PM	PM	E	J	J	J	J	J	J	J	J	J	J	J	E	PM	PM	
	C			K	K	K	K	K	K	K	K	K	K	K	K	K			
	B			N	N	N	N	N	N	N	N	N	N	N	N	N			N
	A			H	S	S	S	S	S	S	S	S	S	S	S	H			
2P + 48S + 2P																			

PART NUMBER	ROWS	POWER			SIGNAL						POWER								
		P1	P2	P3	1	2	3	4	5	6	P4	P5	P6						
9-6450130-7	D	PM	PM	PM				E	E										
	C							F	F										
	B							G	G										
	A							H	H										
3P + 24S + 3P																			

(L5)

NO CONTACT LOADED

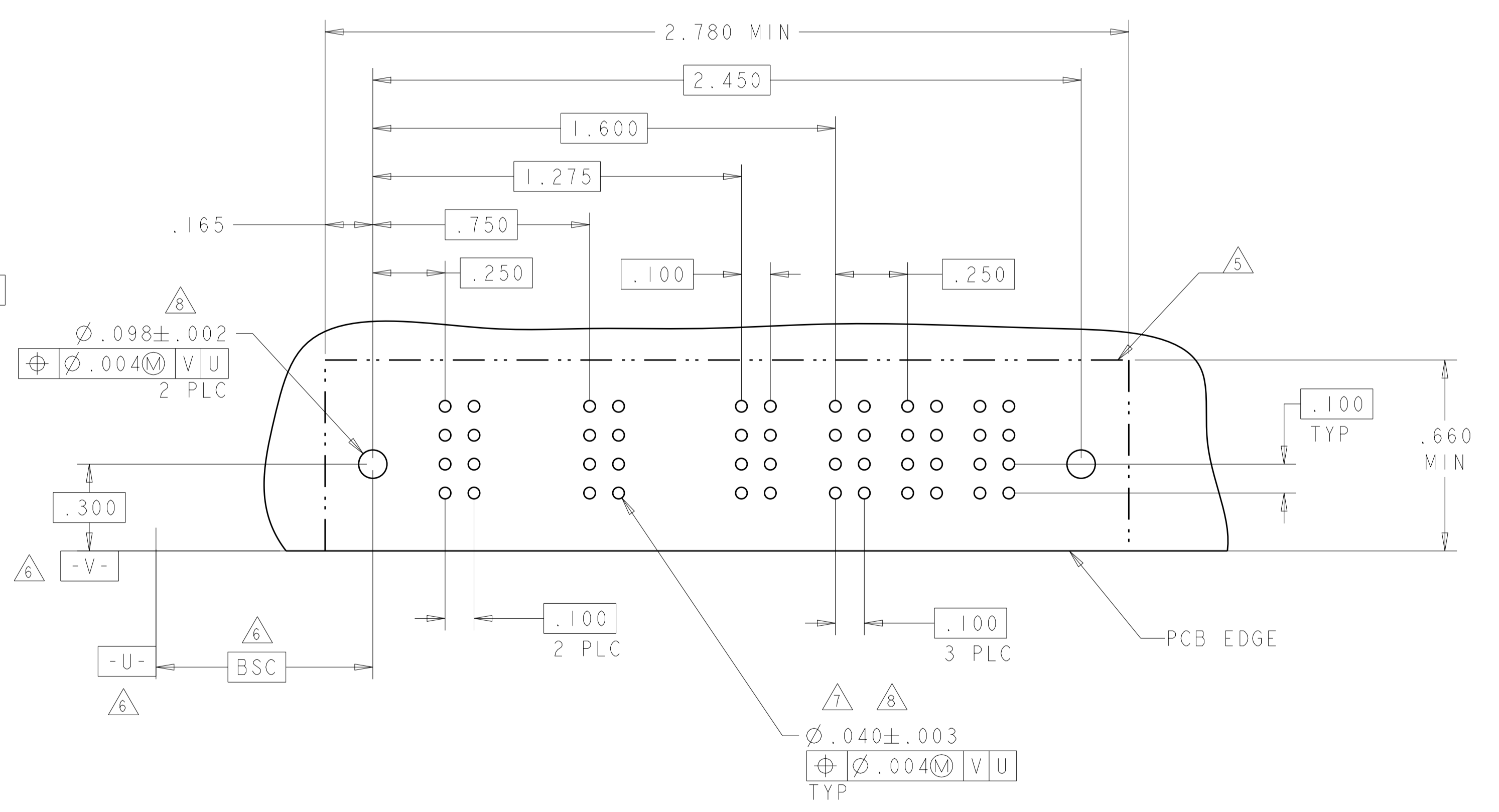
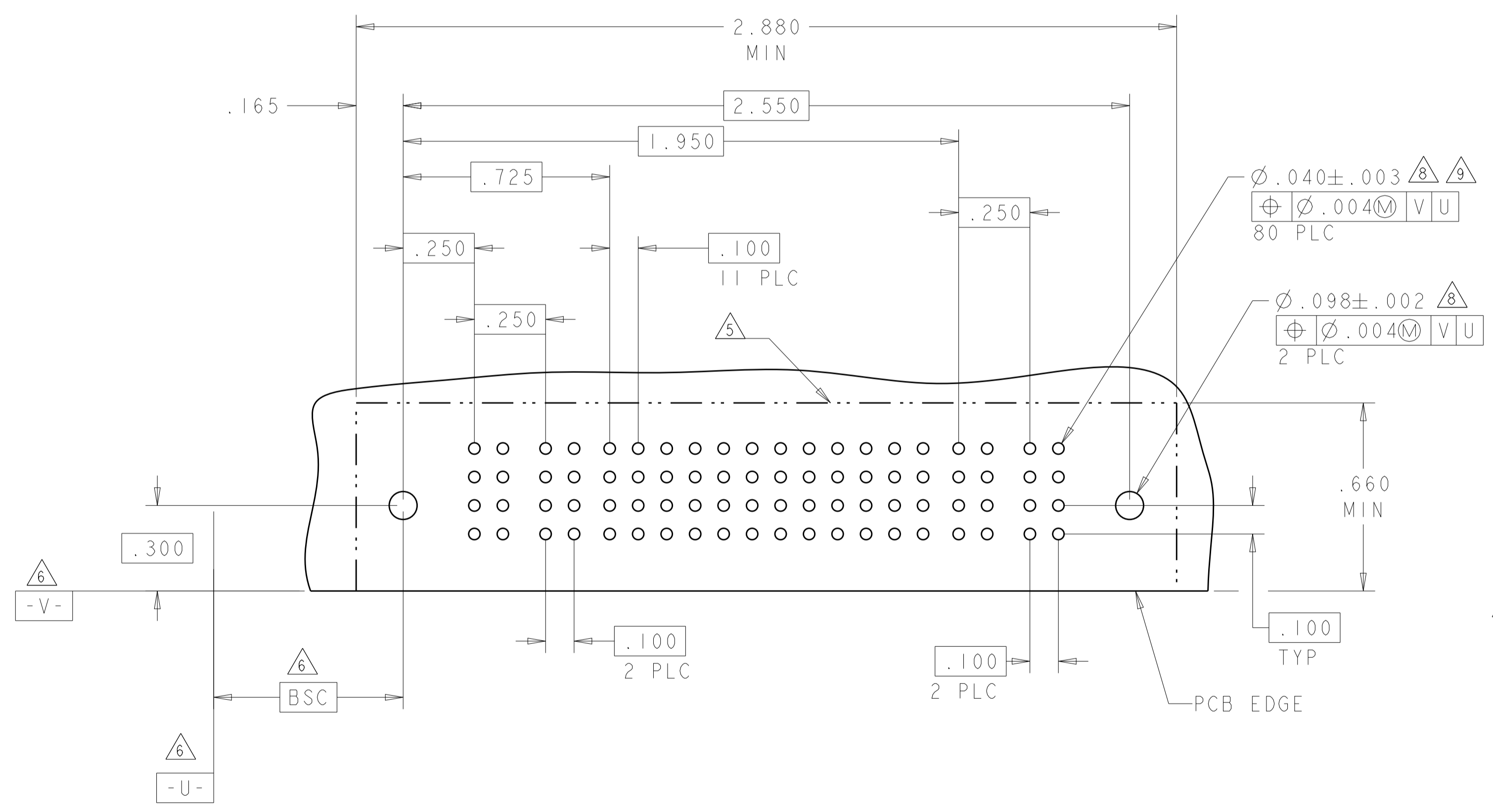

THIS DRAWING IS A CONTROLLED DOCUMENT.

DIMENSIONS:	TOLERANCES UNLESS OTHERWISE SPECIFIED:	OWN: R. GRZYBOWSKI 14FEB2005	CHK: M. PERCHERKE 14FEB2005	APV: M. PERCHERKE 14FEB2005
INCHES	0 PLC ± .01 1 PLC ± .01 2 PLC ± .01 3 PLC ± .005 4 PLC ± .002 ANGLES ± .020	NAME: RIGHT ANGLE HEADER ASSEMBLY W/GUIDES MULTI-BEAM XL	PRODUCT SPEC: 108-1973	APPLICATION SPEC: 114-13038
MATERIAL:	FINISH:	SIZE: A100779	CAGE CODE: C=6450130	RESTRICTED TO:
		Customer Drawing	SCALE: 4:1	SHEET 24 OF 28

STE TE Connectivity

LOC	DIST	REVISIONS					
		P	LTH	DESCRIPTION	DATE	DWN	APVD
ES	00	-	-	SEE SHEET 1	-	-	-

PART NUMBER	ROWS	POWER		SIGNAL						POWER			
		P1	P2	1	2	3	4	5	6	P3	P4	P5	P6
9-6450130-8	D	PM	PM	E	J	J	J	J	E	PM	PM	PM	PM
	C			F	K	K	K	K	F				
	B			N	N	N	N	N	N				
	A			S	S	S	S	S	S				

2P + 24S + 4P

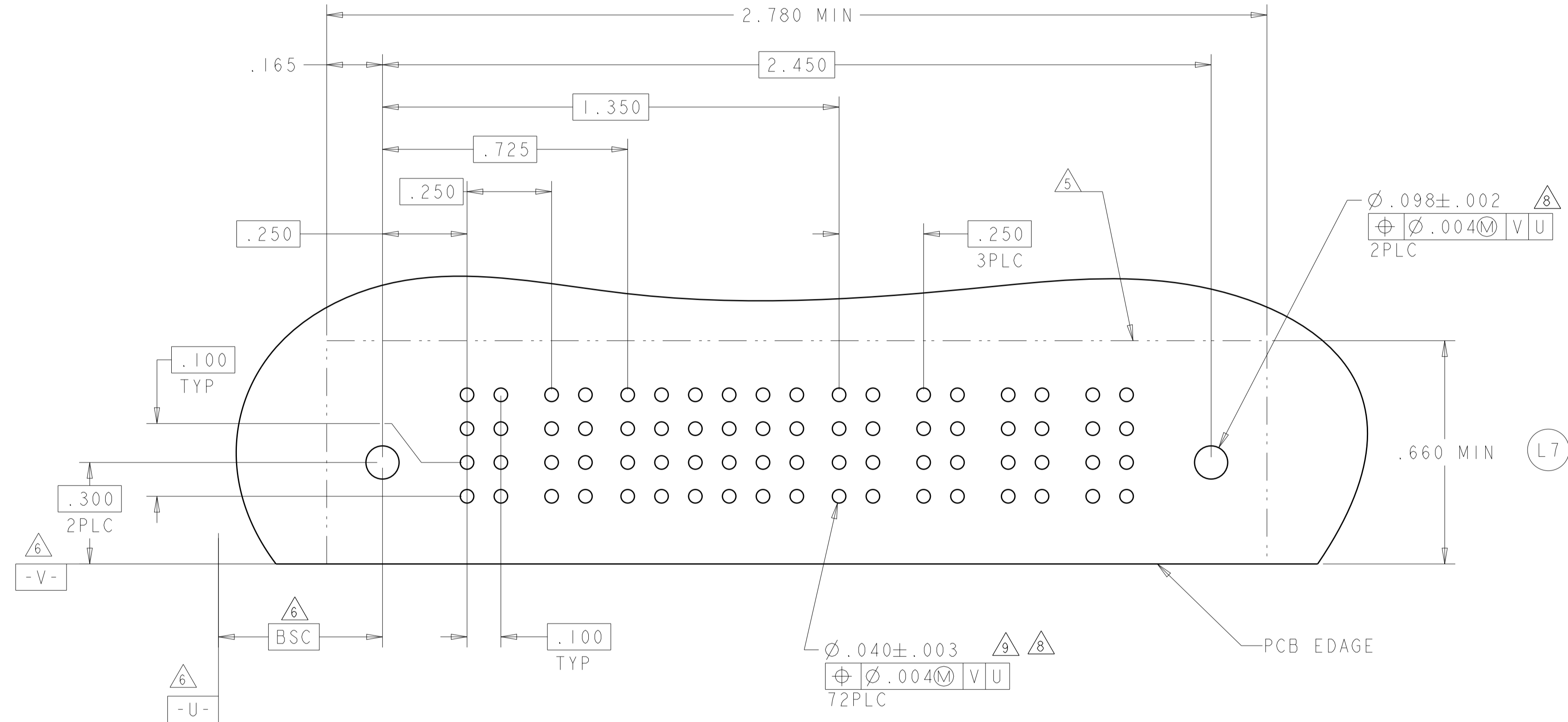

THIS DRAWING IS A CONTROLLED DOCUMENT.		DWN: R.GRZYBOWSKI 14FEB2005	TE Connectivity
DIMENSIONS: INCHES		CHK: M.PERCHEKKE 14FEB2005	
		APVD: M.PERCHEKKE 14FEB2005	NAME: RIGHT ANGLE HEADER ASSEMBLY W/GUIDES MULTI-BEAM XL
TOLERANCES UNLESS OTHERWISE SPECIFIED:		PRODUCT SPEC: 108-1973	SIZE: A1
0 PLC ±.01		APPLICATION SPEC: 114-13038	CAGE CODE: C=6450130
1 PLC ±.01		WEIGHT: -	RESTRICTED TO: -
2 PLC ±.01		MATERIAL: -	SCALE: 4:1
3 PLC ±.005		FINISH: -	SHEET: 25 OF 28
4 PLC ±.0020		Customer Drawing	REV: M2
ANGLES: ±.2°			

LOC		DIST		REVISIONS			
ES	00	P	LTN	DESCRIPTION	DATE	DMN	APVD
-	-	-	-	SEE SHEET 1	-	-	-

PART NUMBER	ROWS	POWER		SIGNAL								POWER		
		PI	P2	1	2	3	4	5	6	7	8	PI	P2	
9-6450130-9	D	PM	PM	J	J	J	J	J	J	J	J	J	J	
	C			K	K	K	F	K	K	K	K	K	K	
	B			N	N	N	N	N	N	N	N	N	N	N
	A			S	S	S	S	S	S	S	S	S	S	S
IP + 32S + IP		HD	HD									HD	HD	

(L8)

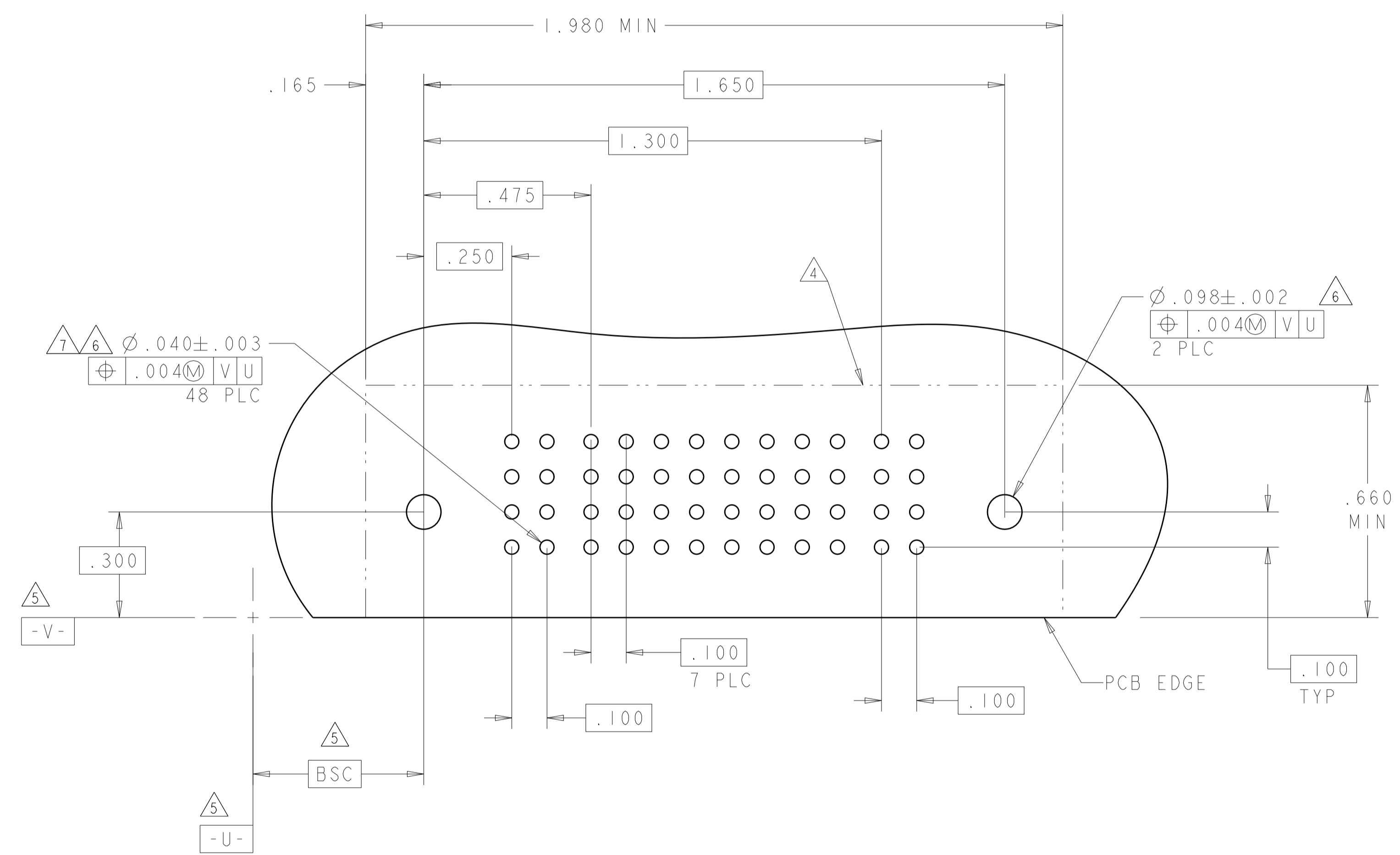

THIS DRAWING IS A CONTROLLED DOCUMENT.		DMN: R. GRZYBOWSKI 14FEB2005	TE Connectivity
DIMENSIONS: INCHES		CHK: M. PERCHERKE 14FEB2005	
TOLERANCES UNLESS OTHERWISE SPECIFIED: 0 PLC ±. 1 PLC ±.01 2 PLC ±.01 3 PLC ±.005 4 PLC ±.0020 ANGLES ±.2°		APVD: M. PERCHERKE 14FEB2005	NAME: RIGHT ANGLE HEADER ASSEMBLY W/GUIDES MULTI-BEAM XL
MATERIAL: -		PRODUCT SPEC: 108-1973	SIZE: A1
FINISH: -		APPLICATION SPEC: 114-13038	CAGE CODE: C=6450130
WEIGHT: -		RESTRICTED TO: -	SCALE: 4:1
Customer Drawing		Customer Drawing	SHEET 26 OF 28 REV M2

LOC	DIST	REVISIONS					
ES	00	P	LTN	DESCRIPTION	DATE	DMN	APVD
		-		SEE SHEET 1			

(L9)

PART NUMBER	ROWS		POWER			SIGNAL		POWER		
			P1	P2	P3	1	2	P4	P5	
7-6450130-1	D		PM	PM	PM	J	J	PM	PM	
	C					K	K			
	B					N	N			
	A					H	S			
3ACP + 8S + 2P										

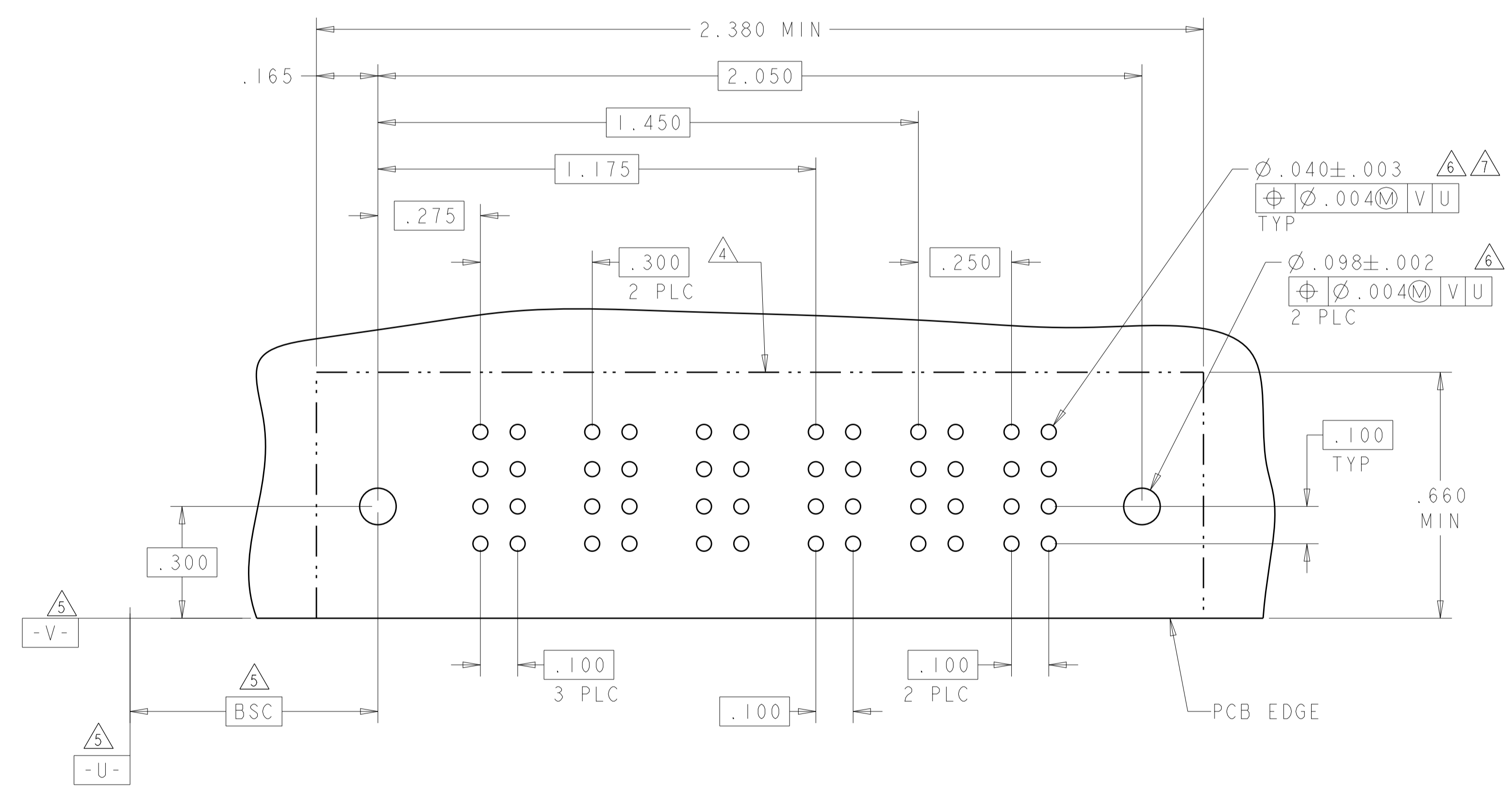

THIS DRAWING IS A CONTROLLED DOCUMENT.		DMN R. GRZYBOWSKI	14FEB2005	 TE Connectivity
DIMENSIONS: INCHES		CHK M. PERCHERKE	14FEB2005	
		TOLERANCES UNLESS OTHERWISE SPECIFIED: 0 PLC ±. 1 PLC ±.01 2 PLC ±.01 3 PLC ±.005 4 PLC ±.0020 ANGLES ±.2°		NAME RIGHT ANGLE HEADER ASSEMBLY W/GUIDES MULTI-BEAM XL
MATERIAL		PRODUCT SPEC 108-1973 APPLICATION SPEC 114-13038		SIZE CAGE CODE DRAWING NO A100779C=6450130
		FINISH WEIGHT Customer Drawing		RESTRICTED TO SCALE 4:1 SHEET 27 OF 28 REV M2

LOC	DIST	REVISIONS			
P	LTN	DESCRIPTION	DATE	DMN	APVD
-	-	SEE SHEET 1	-	-	-

PART NUMBER	ROWS	POWER				SIGNAL						POWER		
		P1	P2	P3	P4	1	2	3	4	5	6	P5	P6	P7
5-6450130-3	D C B A	PM	PM	PM	PM	J	J	J	J	J	J	PM	PM	PM
						K	K	K	K	K	K			
						N	N	N	N	N	N			
						H	S	S	S	S	S			
4HDP + 24S + 3HDP														

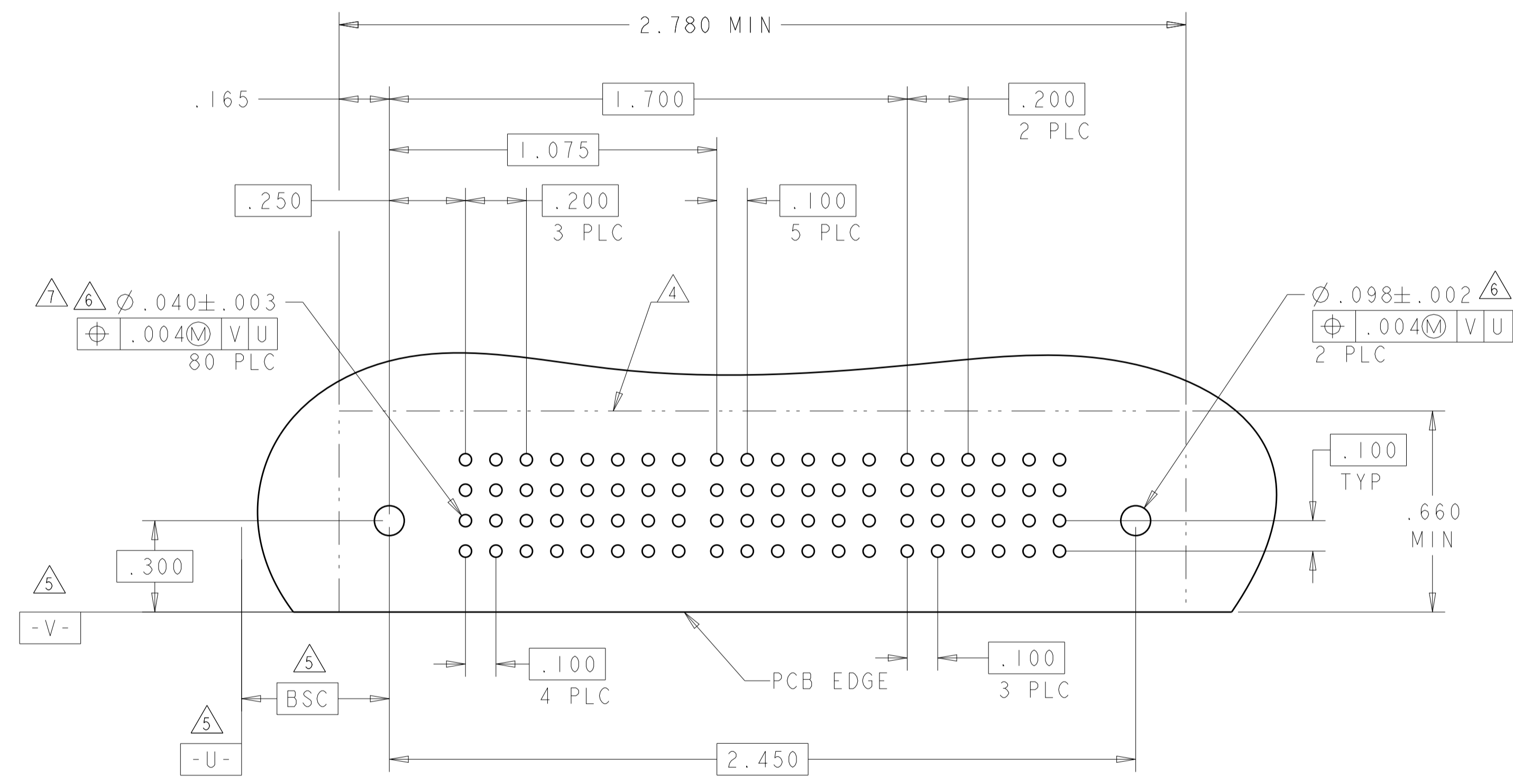

THIS DRAWING IS A CONTROLLED DOCUMENT.

DIMENSIONS: INCHES	TOLERANCES UNLESS OTHERWISE SPECIFIED:	0 PLC ±.01 1 PLC ±.01 2 PLC ±.01 3 PLC ±.005 4 PLC ±.0020 ANGLES ±.2°	FINISH	APPROVED: M. PERCHERKE	DATE: 14 FEB 2005	NAME: M. PERCHERKE	PRODUCT SPEC: 108-1973	APPLICATION SPEC: 114-13038	WEIGHT: -	SCALE: 4:1	SHEET: 28	OF: 28	REV: M2
-----------------------	--	--	--------	------------------------	-------------------	--------------------	------------------------	-----------------------------	-----------	------------	-----------	--------	---------

Customer Drawing

STC TE Connectivity

RIGHT ANGLE HEADER ASSEMBLY W/GUIDES MULTI-BEAM XL

SIZE: A1 CAGE CODE: 6450130 DRAWING NO: 100779